



S1930E

S1932E

S2632E

# OPERATOR'S MANUAL

Part Number 1360460  
March 2013

Serial number 000000 and after  
Replaces July 2012

# **DANGER**

The aerial platform is not electrically insulated. Death or serious injury will result from contact with, or inadequate clearance from, an energized conductor.

Do not go closer than the minimum safe approach distance as defined by the Minimum Safe Approach Distance section in Chapter 3–Safety.

Regard all conductors as energized.

Allow for electrical wire sag and aerial platform sway.

If the platform, scissors structure, or any part of the aerial platform contacts a high-voltage electrical conductor, the entire machine can become electrically charged.

If that happens, remain on the machine and do not contact any other structure or object. This includes the ground, adjacent buildings, poles, and any other objects that are not part of the aerial platform.

Such contact could make your body a conductor to the other object, creating an electrical shock hazard resulting in death or serious injury.

If an aerial platform is in contact with an energized conductor the platform operator must warn ground personnel in the vicinity to stay away. Their bodies can conduct electricity creating an electrical shock hazard resulting in death or serious injury.

Do not approach or leave the aerial platform until the electricity has been turned off.

Do not attempt to operate the lower controls when the platform, scissors structure, or any part of the aerial platform is in contact with a high-voltage electrical conductor or if there is an immediate danger of such contact.

Personnel on or near an aerial platform must be continuously aware of electrical hazards, recognizing that death or serious injury can result from contact with an energized conductor.

## California

### Proposition 65 Warning

Battery posts, terminals, and related accessories contain lead and lead components, chemicals known to the State of California to cause cancer and birth defects or other reproductive harm. Wash hands after handling.

# Table of Contents

Electrical Danger .....	inside front cover
Proposition 65 Warning .....	inside front cover

## Chapter 1 – Introduction

Aerial Platform Features.....	1
Options .....	1
Operator’s Manual.....	1
Safety Alerts .....	1
Operation.....	1
Maintenance .....	2
Manual of Responsibilities.....	2
Additional Information.....	2

## Chapter 2 – Specifications

Component Identification.....	3
General Specifications – S1930E.....	4
Aerial Platform.....	4
Platform .....	4
Function Speed .....	4
Drive System.....	4
Drive/Lift Level Sensor Interlock .....	4
Tires .....	4
Electrical System.....	4
Hydraulic System .....	4
Ambient Air Temperature Operating Range .....	4
Maximum Wind Speed .....	4
General Specifications – S1932E.....	5
Aerial Platform.....	5
Platform .....	5
Function Speed .....	5
Drive System.....	5
Drive/Lift Level Sensor Interlock .....	5
Tires .....	5
Electrical System.....	5
Hydraulic System .....	5
Ambient Air Temperature Operating Range .....	5
Maximum Wind Speed .....	5
General Specifications – S2632E.....	6
Aerial Platform.....	6
Platform .....	6
Function Speed .....	6
Drive System.....	6
Drive/Lift Level Sensor Interlock .....	6
Tires .....	6
Electrical System.....	6
Hydraulic System .....	6
Ambient Air Temperature Operating Range .....	6
Maximum Wind Speed .....	6

## Chapter 3 – Safety

Electrocution Hazards .....	7
Minimum Safe Approach Distance .....	7
Prestart Inspection.....	8
Work Place Inspection and Practices .....	8
Operation.....	8
Tip-Over and Falling Hazards.....	8
Electrical System.....	9
Hydraulic System.....	9
Placards and Decals.....	9

## Chapter 4 – Safety Devices

Emergency Stop Controls.....	11
Drive Motion Alarm .....	11
Pothole Protector Skids.....	11
Drive/Lift Pothole Protector Interlock.....	12
Drive/Lift Level Sensor Interlock.....	12
Lowering Alarm.....	12
Emergency Lowering System.....	12
Safety Prop.....	12
Guardrails .....	13
Ground Fault Circuit Interrupter.....	13
Tilt Alarm.....	13
Horn.....	13
Flashing Light .....	13

## Chapter 5 – Gauges and Displays

Hour Meter.....	15
Battery Charge Indicator .....	15
Battery Condition Indicator .....	15
Diagnostic Center Display .....	16

## Chapter 6 – Batteries

General Maintenance .....	17
Charging.....	17

## Chapter 7 – Controls

Battery Disconnect .....	19
Lower Controls .....	19
Emergency Stop Button .....	19
Control Selector Switch .....	19
Platform Raise/Lower Switch .....	19
Upper Controls .....	20
Emergency Stop Button .....	20
Drive/Lift Selector Switch .....	20
Joystick .....	20
Interlock Switch .....	21
Steer Switch .....	21
Drive Range Switch – S2632E Only .....	21
Horn Button.....	21
Battery Condition Indicator.....	21
Circuit Breaker Reset Button .....	21

## Chapter 8 – Prestart Inspection

Operator’s Manual.....	23
Electrical System.....	23
Battery Fluid Level .....	23
Battery Terminals.....	24
Battery Charger.....	24
Safety Prop.....	24
Cables and Wiring Harness.....	25
Hydraulic System.....	25
Fluid Level.....	25
Hoses, Tubes, and Fittings.....	25
Free-Wheeling Valve .....	25
Tires and Wheels.....	26
Ground Strap .....	26

Lower Control Station .....26  
 Operating Controls .....26  
 Emergency Stop .....27  
 Lowering Alarm .....27  
 Pothole Protector Interlock .....27  
 Emergency Lowering System .....27  
 Structures .....28  
 Weldments .....28  
 Slide Blocks .....28  
 Fasteners .....29  
 Upper Control Station .....29  
 Guardrail System .....29  
 Platform Extension .....29  
 Fold Down Rails .....30  
 Operating Controls .....30  
 Emergency Stop .....31  
 Horn Button .....31  
 Lowering Alarm .....31  
 Drive Alarm .....31  
 Electrical Power Outlet .....31  
 Flashing Lights .....31  
 Battery Condition Indicator .....31  
 Placards and Decals .....32  
 Prestart Inspection Checklist .....35

**Chapter 9 – Operation**

Preparing for Operation .....37  
 Lower Controls .....37  
 Upper Controls .....37  
 Platform .....38  
 Raising and Lowering .....38  
 Extending .....38  
 Wallboard Loading Gate .....39  
 Driving and Steering .....39  
 Drive Range Switch – S2632E Only .....40  
 Drive Speeds .....40  
 Drive/Lift Level Sensor Interlock .....40  
 Fold Down Guardrails .....40  
 Swing-Out Trays .....41  
 Electrical Power Outlet .....41

**Chapter 10 – Stowing and Transporting**

Stowing .....43  
 Transporting .....43  
 Lifting With a Forklift .....43  
 Winching .....44  
 Driving .....45  
 Hoisting .....45  
 Securing for Transport .....46

**Chapter 11 – Emergency Operation**

Emergency Lowering .....47  
 Towing .....48

**Chapter 12 – Troubleshooting**

Troubleshooting Chart .....49

Appendix A – Glossary

Limited Warranty

# Chapter 1 – Introduction

## Aerial Platform Features

The aerial platform is a self-propelled scissors lift that has been designed to raise personnel, their tools, and material to the workstation. The aerial platform has been designed for use on hard surface floors such as concrete. The platform is raised and lowered with a hydraulic cylinder. A hydraulic motor on each of the front drive wheels provides power to move the aerial platform.

The standard machine includes the following features:

- Proportional drive and lift up control
- Driveable at full height
- Drive motion alarm
- Non-marking tires
- Automatic pothole protection system
- Level sensor with drive/lift interlock
- Hour meter
- Manual lowering valve
- Lockable battery disconnect switch
- Tie-down lugs
- Lifting lugs
- Heavy duty battery charger
- Swing-out hydraulic and electrical component trays
- Non-slip metal platform floor
- Three foot platform extension
- 125 volt AC electrical outlet with GFCI
- Scissor arm safety support prop
- Lowering alarm
- Removable upper controls
- Horn
- Forklift loadable from three sides
- Rear forklift pockets
- Chain entry gate
- Wallboard loading gate
- Five year limited warranty

The aerial platform has been manufactured to conform to all applicable requirements of the following organizations.

- Occupational Safety and Health Administration (OSHA)
- American National Standards Institute (ANSI)
- Canadian Standards Association (CSA)

## Options

The following options may be provided on the machine:

- Fold down platform rails
- Flashing light
- Battery condition indicator

## Operator's Manual

This manual provides information for safe and proper operation of the aerial platform. Some information in this manual refers to options that may or may not be on your machine. Read and understand the information in this Operator's Manual before operating the aerial platform on the job.

Additional copies of this manual may be ordered from Snorkel. Supply the model and manual part number from the front cover to assure that the correct manual will be supplied.

All information in this manual is based on the latest product information at the time of publication. Snorkel reserves the right to make product changes at any time without obligation.

## Safety Alerts

A safety alert symbol is used throughout this manual to indicate danger, warning, and caution instructions. Follow these instructions to reduce the likelihood of personal injury and property damage. The terms danger, warning, and caution indicate varying degrees of personal injury or property damage that can result if the instruction is not followed.

### Danger

Indicates an imminently hazardous situation which, if not avoided, will result in death or serious injury. This signal word is to be used in the most extreme situations.

### Warning

Indicates a potentially hazardous situation which, if not avoided, could result in death or serious injury.

### Caution

Indicates a potentially hazardous situation which, if not avoided, may result in minor or moderate injury. It may also be used to alert against unsafe practices.

## Notes

Notes are used to provide special information or helpful hints to assist in aerial platform operation, but do not indicate a hazardous situation.

## Operation

The aerial platform has built-in safety features and has been factory tested for compliance with Snorkel specifications and industry standards. However, any personnel lifting aerial platform can be potentially dangerous in the hands of untrained or careless operators.

### Warning

The potential for an accident increases when the aerial platform is operated by personnel who are not trained and authorized. Death or serious injury could result from such accidents. Read and understand the information in this manual and on the placards and decals on the machine before operating the aerial platform on the job.

Training is essential and must be performed by a qualified person.

Become proficient in knowledge and actual operation before using the aerial platform on the job.

The operator must be trained and authorized to perform any functions of the aerial platform.

Operation of the aerial platform must be within the scope of the machine specifications.

The operator bears ultimate responsibility for following all manufacturer's instructions and warnings, regulations and safety rules of their employer and/or any state or federal law.

### Maintenance

Every person who maintains, inspects, tests, or repairs the aerial platform must be qualified to do so. Following the daily prestart inspection in this Operator's Manual will help keep the aerial platform in optimum working condition. Other maintenance functions must be performed by maintenance personnel who are qualified to work on the aerial platform.

### Caution

Welding current can be very intense. Damage to electronic components may result. Connect the ground clamp as close as possible to the area being welded. Disconnect battery cables and any microprocessors and engine control modules before welding on the machine.

If it becomes necessary to weld aerial platform components as a method of repair, take all precautions to prevent damage to electronic circuitry and devices on the machine. This includes, but may not be limited to, disconnecting battery cables and electronic devices.

Do not modify this aerial platform without prior written consent of the Snorkel Engineering Department. Modification may void the warranty, adversely affect stability, or affect the operational characteristics of the aerial platform.

### Manual of Responsibilities

All owners and users of the aerial platform must read, understand, and comply with all applicable regulations. Ultimate compliance to OSHA regulations is the responsibility of the user and their employer.

ANSI publications clearly identify the responsibilities of all personnel who may be involved with the aerial platform. A reprint of the "Manual of Responsibilities for Dealers, Owners, Users, Operators, Lessors and Lessees of ANSI/SIA A92.6-2006 Self-Propelled Elevating Work Platforms" is available from Snorkel dealers or from the factory upon request.

Copies are also available from:

Scaffold Industry Association, Inc.  
P. O. Box 20574  
Phoenix, AZ 85036-0574 USA

### Additional Information

For additional information contact your local dealer or Snorkel at:

Snorkel International  
P.O. Box 1160  
St. Joseph, MO 64502-1160 USA  
1-800-255-0317

<http://www.snorkellifts.com>

# Chapter 2 – Specifications

## Component Identification

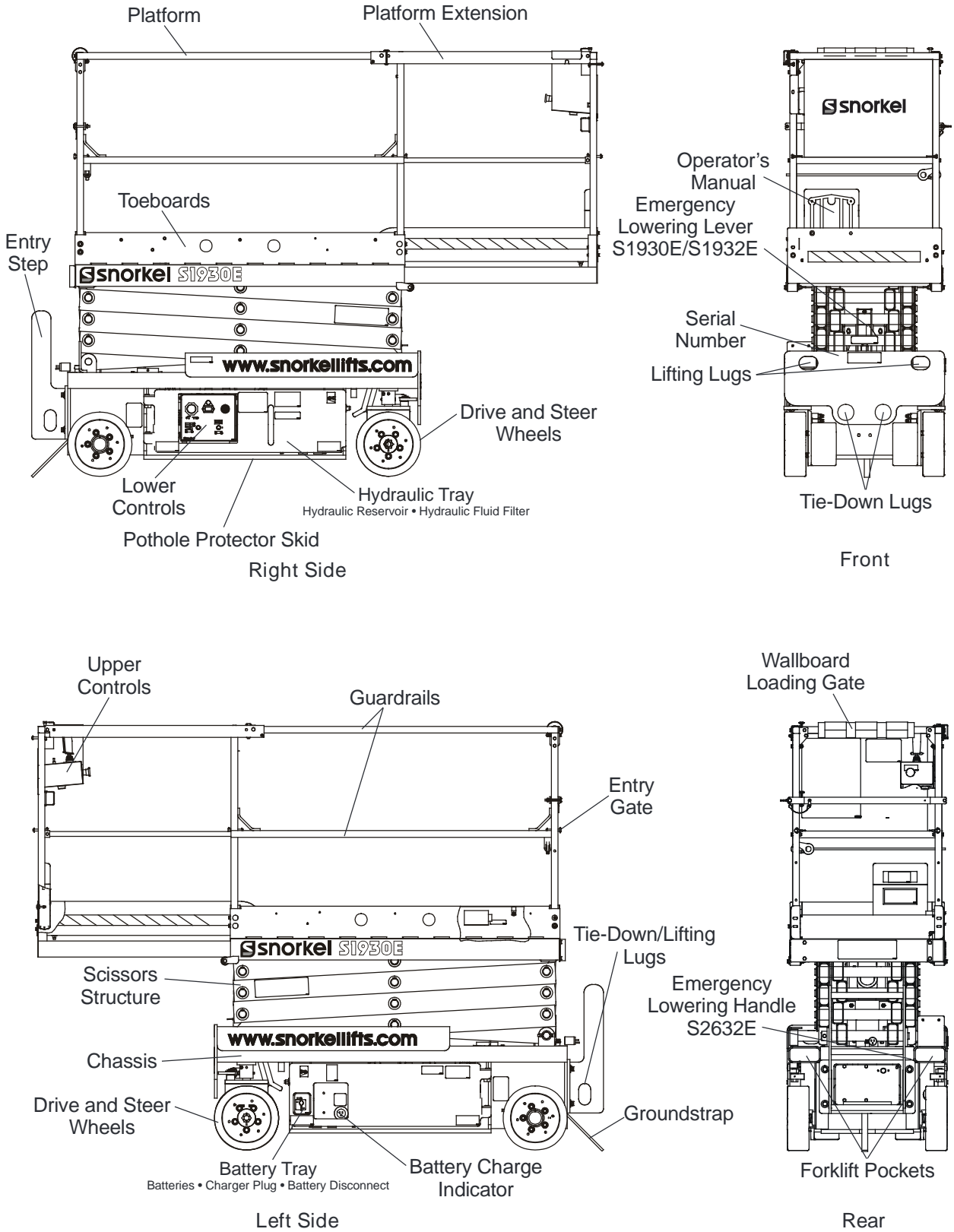

## General Specifications – S1930E

<b>Aerial Platform</b>		<b>Drive System</b>	
Working height	25' (7.6 m)	Standard	Two-wheel drive
Maximum platform height	19' (5.8 m)	Gradeability	25%
Turning radius		Maximum drive height	19' (5.8 m)
Inside	5" (12.7 cm)	<b>Drive/Lift Level Sensor Interlock</b>	
Outside	64.5" (1.64 m)	Side-to-side	2 degrees
Wheelbase	4' 6" (1.37 m)	Front-to-rear	4 degrees
Ground clearance		<b>Tires</b>	
Pothole protector raised	2.5" (6.3 cm)	Nonmarking solid rubber 12" x 4" (30.5 cm x 10.2 cm)	
Pothole protector lowered	0.75" (1.9 cm)	<b>Electrical System</b>	
Maximum wheel load	1,416 lbs (642 kg)	Voltage	24 V DC negative chassis ground
Maximum ground pressure	175 psi (12.3 kg/cm <sup>2</sup> )	Source	Four - 6 V 220 amp hour batteries
Weight, EVW		Fluid recommended	distilled water
Approximate	3,175 lbs (1,440 kg)	Charger	25 amp
Stowed width	30" (76.2 cm)	<b>Hydraulic System</b>	
Stowed length	6' 2" (1.9 m)	Maximum pressure	3,000 psi (20,684 kPa)
With step removed	5' 6" (1.7 m)	Reservoir capacity	3 US gal (11.35 l)
Stowed height	6' 7" (2.17 m)	System capacity	3.5 US gal (13.2 l)
Rails up	85.25" (216.5 cm)	Maximum operating temperature	160°F (71°C)
Rails down	64.5" (164 cm)	Hydraulic fluid recommended	
<b>Platform</b>		Above 10°F (-12°C)	ISO VG32 (Mobil DTE-13M)
<b>Dimensions</b>		Below 10°F (-12°C)	ISO VG15 (Mobil DTE-11M)
Main	29" x 61.5" (74 cm x 156 cm)	<b>Ambient Air Temperature Operating Range</b>	
Extension	24" x 36" (61 cm x 91.4 cm)	Fahrenheit	0°F to 110°F
Total length with extension	97.5" (247.5 cm)	Celsius	-18°C to 43°C
Guardrail height		<b>Maximum Wind Speed</b>	
Rails up	44" (111.8 cm)	Gust or steady	28 mph (12.5 m/s)
Rails down	24.5" (62.2 cm)		
Toeboard height	6" (15.2 cm)		
<b>Rated work load</b>			
Total	500 lb (227 kg)		
Extension	250 lb (113.3 kg)		
Maximum number of occupants	1 outdoors		
	2 indoors		
AC outlet	120 V, 15 amp		
<b>Function Speed</b>			
Platform raise	12 to 20 seconds		
Platform lower	20 to 26 seconds		
High Drive			
Platform lower than 6' (1.8 m)	0 to 2 mph (0 to 3.2 km/h)		
Low Drive			
Platform higher than 6' (1.8 m)	0 to 0.4 mph (0 to 0.6 km/h)		



## General Specifications – S1932E

<b>Aerial Platform</b>		<b>Drive System</b>	
Working height	25' (7.6 m)	Standard	Two-wheel drive
Maximum platform height	19' (5.8 m)	Gradeability	25%
Turning radius		Maximum drive height	19' (5.8 m)
Inside	5" (12.7 cm)	<b>Drive/Lift Level Sensor Interlock</b>	
Outside	64.5" (1.64 m)	Side-to-side	2 degrees
Wheelbase	4' 6" (1.37 m)	Front-to-rear	4 degrees
Ground clearance		<b>Tires</b>	
Pothole protector raised	2.5" (6.3 cm)	Nonmarking solid rubber	12" x 4" (30.5 cm x 10.2 cm)
Pothole protector lowered	0.75" (1.9 cm)	<b>Electrical System</b>	
Maximum wheel load	1,416 lbs (642 kg)	Voltage	24 V DC negative chassis ground
Maximum ground pressure	175 psi (12.3 kg/cm <sup>2</sup> )	Source	Four - 6 V 220 amp hour batteries
Weight, EVW		Fluid recommended	distilled water
Approximate	3,000 lbs (1,361 kg)	Charger	25 amp
Stowed width	32" (81.3 cm)	<b>Hydraulic System</b>	
Stowed length	6' 2" (1.9 m)	Maximum pressure	3,000 psi (20,684 kPa)
With step removed	5' 6" (1.7 m)	Reservoir capacity	3 US gal (11.35 l)
Stowed height	6' 7" (2.17 m)	System capacity	3.5 US gal (13.2 l)
Rails up	85.25" (216.5 cm)	Maximum operating temperature	160°F (71°C)
Rails down	64.5" (164 cm)	Hydraulic fluid recommended	
<b>Platform</b>		Above 10°F (-12°C)	ISO VG32 (Mobil DTE-13M)
<b>Dimensions</b>		Below 10°F (-12°C)	ISO VG15 (Mobil DTE-11M)
Main	29" x 61.5" (74 cm x 156 cm)	<b>Ambient Air Temperature Operating Range</b>	
Extension	24" x 36" (61 cm x 91.4 cm)	Fahrenheit	0°F to 110°F
Total length with extension	97.5" (247.5 cm)	Celsius	-18°C to 43°C
Guardrail height		<b>Maximum Wind Speed</b>	
Rails up	44" (111.8 cm)	Gust or steady	28 mph (12.5 m/s)
Rails down	24.5" (62.2 cm)		
Toeboard height	6" (15.2 cm)		
<b>Rated work load</b>			
Total	500 lb (227 kg)		
Extension	250 lb (113.3 kg)		
Maximum number of occupants	1 outdoors 2 indoors		
<b>Function Speed</b>			
Platform raise	12 to 20 seconds		
Platform lower	20 to 26 seconds		
<b>High Drive</b>			
Platform lower than 6' (1.8 m)	0 to 2 mph (0 to 3.2 km/h)		
<b>Low Drive</b>			
Platform higher than 6' (1.8 m)	0 to 0.4 mph (0 to 0.6 km/h)		

General Specifications – S2632E

<b>Aerial Platform</b>		<b>Drive System</b>	
Working height	32' 3" (9.8 m)	Standard	Two-wheel drive
Maximum platform height	26' 3" (8 m)	Gradeability	25%
Turning radius		Maximum drive height	26' 3" (8 m)
Inside	10" (25.4 cm)	<b>Drive/Lift Level Sensor Interlock</b>	
Outside	92" (234 cm)	Side-to-side	2 degrees
Wheelbase	6' 4" (1.92 m)	Front-to-rear	4 degrees
Ground clearance		<b>Tires</b>	
Pothole protector raised	2.5" (6.3 cm)	Nonmarking solid rubber 15" x 5" (38.1 cm x 12.7 cm)	
Pothole protector lowered	0.75" (1.9 cm)	<b>Electrical System</b>	
Maximum wheel load	2,450 lbs (1,112 kg)	Voltage	24 V DC negative chassis ground
Maximum ground pressure	190 psi (430 kg/cm <sup>2</sup> )	Source	Four - 6 V 220 amp hour batteries
Weight, EVW		Fluid recommended	distilled water
Approximate	5,622 lbs (2,550 kg)	Charger	25 amp
Stowed width	32" (81.3 cm)	<b>Hydraulic System</b>	
Stowed length	93.25" (2.37 m)	Maximum pressure	3,000 psi (20,684 kPa)
With step removed	93.25" (2.37 m)	Reservoir capacity	6.8 US gal (25.7 l)
Stowed height		System capacity	7.3 US gal (27.6 l)
Rails up	91.63" (2.33 m)	Maximum operating temperature	160°F (71°C)
Rails down	76" (1.93 m)	Hydraulic fluid recommended	
<b>Platform</b>		Above 10°F (-12°C) ISO VG32 (Mobil DTE 10 XL32)	
<b>Dimensions</b>		Below 10°F (-12°C) ISO VG15 (Mobil DTE 10 XL15)	
Main	29" x 91" (74 cm x 231 cm)	<b>Ambient Air Temperature Operating Range</b>	
Extension	24" x 36" (61 cm x 91.4 cm)	Fahrenheit	0°F to 110°F
Total length with extension	127" (322.6 cm)	Celsius	-18°C to 43°C
Guardrail height		<b>Maximum Wind Speed</b>	
Rails up	44" (111.8 cm)	Gust or steady	28 mph (12.5 m/s)
Rails down	24.5" (62.2 cm)		
Toeboard height	6" (15.2 cm)		
<b>Rated work load</b>			
Total	500 lb (227 kg)		
Extension	250 lb (113.3 kg)		
Maximum number of occupants	1 outdoors 2 indoors		
<b>Function Speed</b>			
Platform raise	12 to 20 seconds		
Platform lower	20 to 26 seconds		
High Drive			
Platform lower than 6' (1.8 m)	0 to 2 mph (0 to 3.2 km/h)		
Low Drive			
Platform higher than 6' (1.8 m)	0 to 0.4 mph (0 to 0.6 km/h)		

## Chapter 3 – Safety

Knowledge of the information in this manual, and proper training, provide a basis for safely operating the aerial platform. Know the location of all controls and how they operate to act quickly and responsibly in an emergency.

Safety devices reduce the likelihood of an accident.

Never disable, modify, or ignore any safety device.

Safety alerts in this manual indicate situations where accidents may occur.

If any malfunction, hazard or potentially unsafe condition relating to capacity, intended use, or safe operation is suspected, stop aerial platform operation and seek assistance.

The operator bears ultimate responsibility for following all manufacturer's instructions and warnings, regulations and safety rules of their employer and/or any state or federal law.

### Electrocution Hazards

The aerial platform is made of metal components and is not insulated. Regard all conductors as energized. Do not operate outside during a thunderstorm.

### Minimum Safe Approach Distance

Minimum safe approach distances to energized power lines and their associated parts must be observed while operating the aerial platform.

#### **⚠ Danger**

The aerial platform is not electrically insulated. Death or serious injury will result from contact with, or inadequate clearance from, an energized conductor. Do not go closer than the minimum safe approach distance as defined by ANSI.

ANSI publications define minimum distances that must be observed when working near bus bars and energized power lines. Table 1 and Figure 3 are reprinted courtesy of Scaffold Industry Association, ANSI/SIA A92.6.

Voltage Range (Phase to Phase)	Minimum Safe Approach Distance	
	Feet	Meters
0 to 300V	Avoid Contact	
Over 300V to 50kV	10	3.05
Over 50kV to 200kV	15	4.60
Over 200kV to 350kV	20	6.10
Over 350kV to 500kV	25	7.62
Over 500kV to 750kV	35	10.67
Over 750kV to 1000kV	45	13.72

Table 1 – Minimum Safe Approach Distance

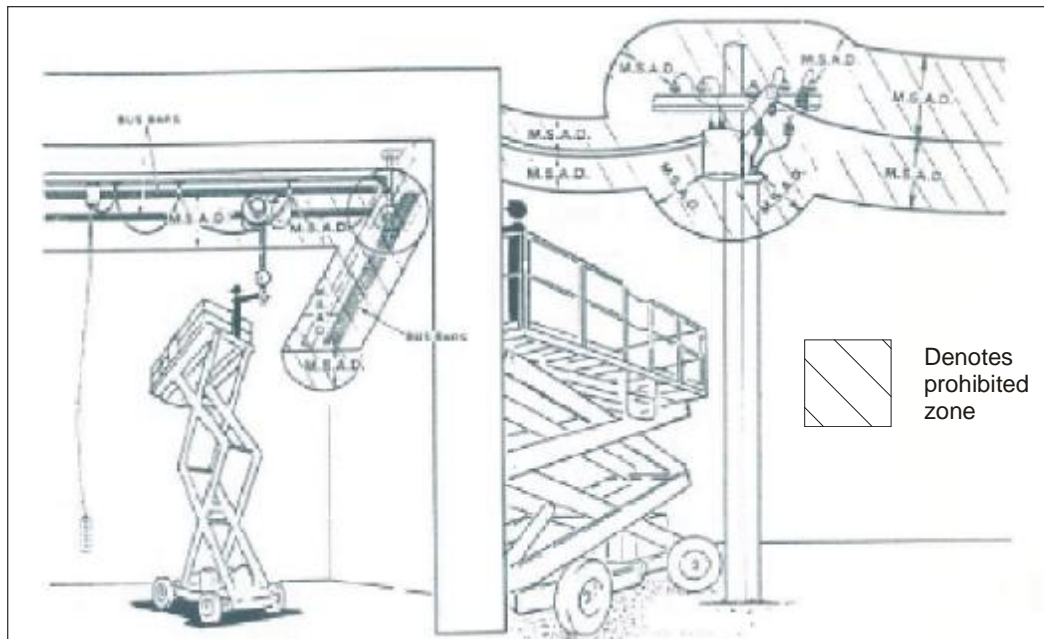

Figure 3 – Minimum Safe Approach Distance

## Prestart Inspection

Perform a prestart inspection before each shift as described in Chapter 8. Do not use the aerial platform on the job unless you are trained and authorized to do so.

## Work Place Inspection and Practices

Do not use the aerial platform as a ground connection when welding.

The welding ground clamp must be attached to the same structure that is being welded.

Electrical current flow can be very intense, causing serious internal damage to some components.

Inspect the area before and during aerial platform use. The following are some potential hazards that may be in the work place:

- Debris
- Slopes
- Drop-offs or holes
- Bumps and floor obstructions
- Overhead obstructions
- Unauthorized persons
- High voltage conductors
- Wind and weather conditions
- Inadequate surface and support to withstand load forces applied by the aerial platform in all operating configurations

Before using the aerial platform in any hazardous (classified) location, make certain it is approved and of the type required by ANSI/NFPA 505 for use in that particular location.

Know and understand the job site traffic flow patterns and obey the flagmen, road signs and signals.

While operating the aerial platform, a good safety practice is to have qualified personnel in the immediate work area to:

- Help in case of an emergency
- Operate emergency controls as required
- Watch for loss of control by platform operator
- Warn the operator of any obstructions or hazards that may not be obvious to them
- Watch for soft terrain, sloping surfaces, drop-offs, etc. where stability could be jeopardized
- Watch for bystanders and never allow anyone to be under, or to reach through the scissors structure while operating the aerial platform

## Danger

Pinch points may exist between moving components. Death or serious injury will result from becoming trapped between components, buildings, structures, or other obstacles. Make sure there is sufficient clearance around the machine before moving the chassis or platform. Allow sufficient room and time

to stop movement to avoid contact with structures or other hazards.

Always look in the direction of movement.

Drive with care and at speeds compatible with the work place conditions.

Use caution when driving over rough ground, on slopes and when turning.

Do not engage in any form of horseplay or permit riders any place other than in the platform.

Secure all accessories, containers, tools and other materials in the platform to prevent them from accidentally falling or being kicked off the platform. Remove all objects that do not belong in or on the aerial platform.

Never steady the platform by positioning it against another platform.

## Warning

The potential for an accident increases when operating an aerial platform that is damaged or malfunctioning. Death or serious injury could result from such accidents. Do not operate the aerial platform if it is damaged or malfunctioning.

Do not operate the aerial platform if it is damaged or not functioning properly. Qualified maintenance personnel must correct the problem before putting the aerial platform back into service.

## Operation

Use three points of support when entering or exiting the platform. For example, use two hands and one foot when climbing into the platform.

Make sure the area below the platform is free of personnel before lowering.

Keep both feet positioned firmly on the platform floor.

Operate the controls slowly and deliberately to avoid jerky and erratic operation.

Always stop the controls in neutral before going in the opposite direction.

Do not dismount while the aerial platform is in motion or jump off the platform.

Properly stow the aerial platform and secure it against unauthorized operation at the end of each work day, before transporting, or if it is left unattended.

## Tip-Over and Falling Hazards

Operate the aerial platform only on a firm, flat, level surface capable of withstanding all load forces imposed by the aerial platform in all operating conditions. Refer to the General Specifications chart for the maximum

wheel load and drive/lift level sensor interlock information. Raise the platform only when the aerial platform is on level ground.

### Danger

The aerial platform can tip over if it becomes unstable. Death or serious injury will result from a tip-over accident. Do not drive or position the aerial platform for elevated use near any drop-off, hole, slope, soft or uneven ground, or other tip-over hazard. Do not raise the platform outdoors in wind speeds above 28 mph (12.5 m/s).

Do not operate the aerial platform within 4' (1.2 m) of any drop-off or hole.

Do not raise the platform in winds above 28 mph (12.5 m/s). Do not add anything to the aerial platform that will increase the wind loading such as billboards, banners, flags, etc.

Never operate the aerial platform without all parts of the guardrail system in place and the safety gate closed. Make sure that all protective guards, cowlings, and doors are securely fastened.

Do not exceed the platform capacity nor the platform-extension capacity as indicated on the platform rating placard on the platform. Do not carry loads that extend beyond the platform guardrails without prior written consent from Snorkel.

Do not operate the aerial platform from trucks, trailers, railway cars, floating vessels, scaffolds, or similar equipment unless the application is approved in writing by Snorkel.

Do not use the aerial platform as a crane, hoist, jack or for any purpose other than to position personnel, tools, and materials.

Do not climb on the guardrails or use ladders, planks, or other devices to extend or increase the work position from the platform.

Take care to prevent rope, electrical cords, and hoses, etc., from becoming caught in or on the aerial platform.

If the platform or scissors structure becomes caught on an adjacent structure or other obstacle and is prevented from normal motion, reverse the control to free the platform.

If control reversal does not free the platform, evacuate the platform before attempting to free it.

It is best not to transfer from the platform to another structure or from the structure to the platform, unless that is the safest way to do the job. Judge each situation separately taking the work environment into account. If it is necessary to transfer from the platform to another structure the following guidelines apply:

1. If you are using a fall restraint, transfer your anchorage from one structure to the other before stepping across.
2. Remember that you might be transferring to a structure where personal fall arrest is required.
3. Use the platform entrance, do not climb over or through the guardrails.

### Electrical System

Charge the batteries in a well-ventilated area free of flame, sparks, or other hazards that might cause fire or explosion.

Do not operate any of the aerial platform functions while the battery charger is plugged in.

### Warning

Batteries give off hydrogen and oxygen that can combine explosively. Death or serious injury could result from a chemical explosion. Do not smoke or permit open flames or sparks when checking the batteries.

Battery acid can damage the skin and eyes. Serious infection or reaction could result if medical treatment is not given immediately. Wear face and eye protection when working near the batteries.

Batteries contain sulfuric acid that can damage your eyes or skin on contact.

Wear a face shield, rubber gloves, and protective clothing when working around batteries.

If acid contacts your eyes, flush immediately with clear water and get medical attention.

If acid contacts your skin, wash off immediately with clear water.

### Hydraulic System

The hydraulic system contains hoses with hydraulic fluid under pressure.

### Danger

Hydraulic fluid escaping under pressure can have enough force to inject fluid into the flesh. Serious infection or reaction will result if medical treatment is not given immediately. In case of injury by escaping hydraulic fluid, seek medical attention at once.

Do not place your hand or any part of your body in front of escaping hydraulic fluid. Use a piece of cardboard or wood to search for hydraulic leaks.

### Placards and Decals

The aerial platform is equipped with placards and decals that provide instruction for operation and accident prevention. Do not operate the aerial platform if any placards or decals are missing, damaged, or illegible.



## Chapter 4 – Safety Devices

This aerial work platform is manufactured with safety devices, placards, and decals to reduce the likelihood of an accident.

For the safety of all personnel, do not disable, modify, or ignore any safety device.

Safety devices are included in the daily prestart inspection.

### **⚠Warning**

The potential for an accident increases when safety devices do not function properly. Death or serious injury could result from such accidents. Do not alter, disable, or override any safety device.

If any safety devices are defective, remove the aerial platform from service until qualified maintenance personnel can make repairs.

### Emergency Stop Controls

There is an emergency stop control at the lower and upper controls. Both the lower and upper control emergency stop buttons must be on to operate the machine.

At the lower controls, the emergency stop is a two-position red push button (refer to Figure 4.1).



Figure 4.1 – Lower Controls

Push the emergency stop button inward to disconnect power to all control circuits.

Pull the button outward to restore power.

#### Note

The lower controls override the upper controls. If the upper control emergency stop button is engaged, the lower controls can still be used to operate the aerial platform.

At the upper controls, the emergency stop is a two-position red push button (refer to Figure 4.2).



Figure 4.2 – Upper Controls

Push the emergency stop button inward to disconnect power to the upper control circuits.

Pull the button outward to restore power.

### Drive Motion Alarm

When the joystick is moved out of neutral to drive the aerial platform, the alarm emits a loud beeping sound to warn personnel in the work area to stand clear.

### Pothole Protector Skids

The pothole protector skids automatically lower when the platform is elevated approximately 24" (61 cm). Ground clearance is reduced from 2 1/2" (6.3 cm) to 3/4" (1.9 cm) when the skids lock into position (refer to Figure 4.3).

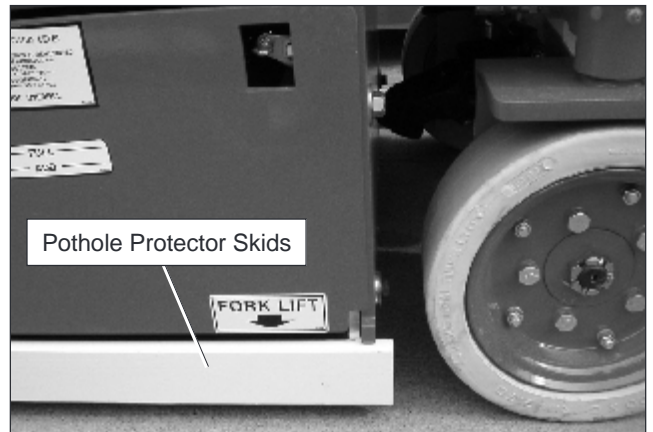

Figure 4.3 – Pothole Protector Skids

### **⚠Danger**

The aerial platform can tip over if it becomes unstable. Death or serious injury will result from a tip-over accident. Do not drive or position the aerial platform for elevated use within 4' (1.2 m) of any drop-off, hole, or other tip-over hazard.

This protection system limits the tilt angle if a wheel is driven into a drop-off or hole. This greatly reduces the likelihood of the aerial platform tipping over.

The pothole protection system is for added protection and does not justify operating near drop-offs or holes.

### Drive/Lift Pothole Protector Interlock

The aerial platform drive and lift functions are interlocked through a limit switch that senses whether or not the pothole protection linkage is locked into position. The drive/lift pothole interlock operates when the platform is elevated approximately 6' (1.8 m).

If an obstruction under the skids, or some other impairment prevents the skids from locking into position, the drive and lift functions will not operate and an alarm will sound.

Lower the platform and remove the obstruction when the drive/lift pothole protector interlock alarm sounds.

### Drive/Lift Level Sensor Interlock

The aerial platform drive and lift functions are interlocked through a level sensor system. The drive/lift level sensor interlock operates when the platform is elevated approximately 6' (1.8 m).

If the chassis is tilted more than 2 degrees side-to-side or more than 4 degrees front-to-rear, the drive and lift functions will not operate and an alarm will sound.

Lower the platform and drive to a level surface when the drive/lift level sensor alarm sounds.

The drive/lift level sensor system is for added protection and does not justify operating on anything other than firm, flat, level surfaces.

### Lowering Alarm

When the joystick is moved out of neutral to lower the platform, the alarm emits a loud beeping sound to warn personnel in the work area to stand clear.

## ⚠ Danger

Pinch points exist on the scissors structure. Death or serious injury will result if the scissors structure lowers onto personnel within the scissors arms or under the raised platform. Stand clear while raising and lowering the platform.

Be careful when lowering the platform. Keep hands and fingers away from the scissors structures components.

### Emergency Lowering System

The emergency lowering system may be used to lower the platform if there is a malfunction in the hydraulic or electrical system.

On S1930E and S1932E machines the lowering lever is at the front of the aerial platform. On S2632E machines a handle at the rear of the chassis is used for emergency lowering (refer to Figure 4.4).

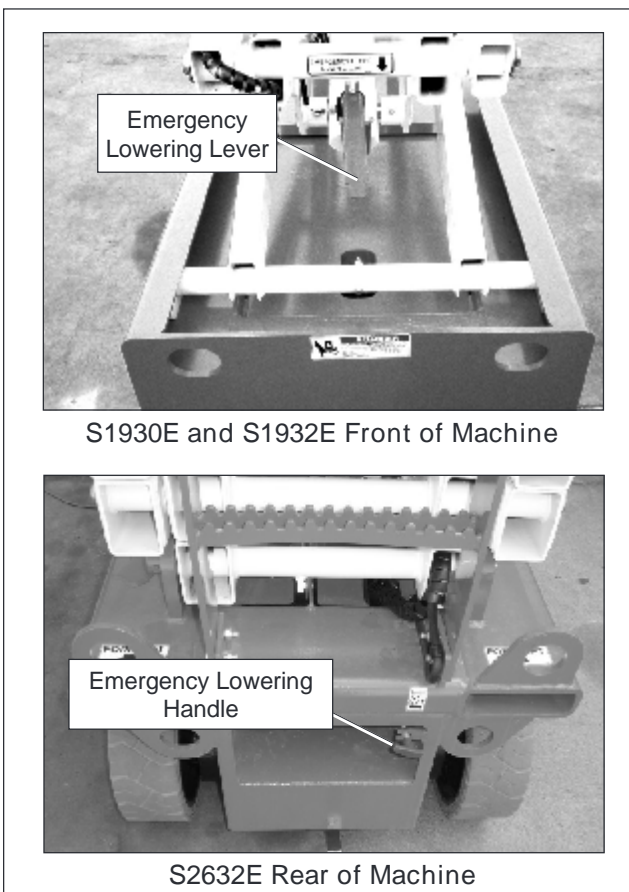

Figure 4.4 – Emergency Lowering System

S1930E and S1932E machines – push downward on the lever to lower the platform.

S2632E machines – pull outward on the handle to lower the platform.

### Safety Prop

The safety prop (refer to Figure 4.5) is used to support the scissors structure when access to the scissors arm components or the chassis is required. Always use the safety prop when the platform is raised during inspection and maintenance.



Figure 4.5 – Safety Prop



## Guardrails

The guardrails (refer to Figure 4.6) help protect personnel from falling off the platform.

The guardrail system includes:

- A top rail
- A mid rail
- An entry gate
- A wallboard loading gate
- Toeboards around the sides of the platform.

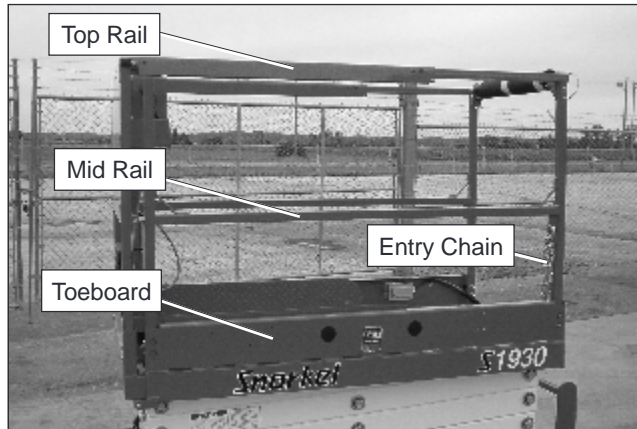

Figure 4.6 – Upper Controls

The entry gate allows for access to the platform. The gate must be securely latched except when personnel are entering or leaving the platform.

The wallboard loading gate can be used for loading work materials in the platform. The gate must be securely fastened closed except when personnel are loading or unloading work materials in the platform.

## Ground Fault Circuit Interrupter

The electrical power outlet (refer to Figure 4.7), at the platform contains a ground fault circuit interrupter (GFCI) to provide protection for personnel.



Figure 4.7 – Electrical Power Outlet

## Tilt Alarm

An alarm will sound if the aerial platform chassis is out of level more than two degrees side-to-side or four degrees front-to-rear when the platform is raised.

### Danger

The aerial platform can tip over if it becomes unstable. Death or serious injury will result from a tip-over accident. Do not drive or position the aerial platform for elevated use near any drop-off, hole, slope, soft or uneven ground, or other tip-over hazard.

Completely lower the platform and drive to a level surface when the tilt alarm sounds.

The tilt alarm is for added protection and does not justify operating on anything other than firm, flat, level surfaces.

## Horn

The horn may be used to warn personnel on the ground. The horn is operational when the machine is set up for operation from the upper controls.

The horn button is located on the upper control panel (refer to Figure 4.8).

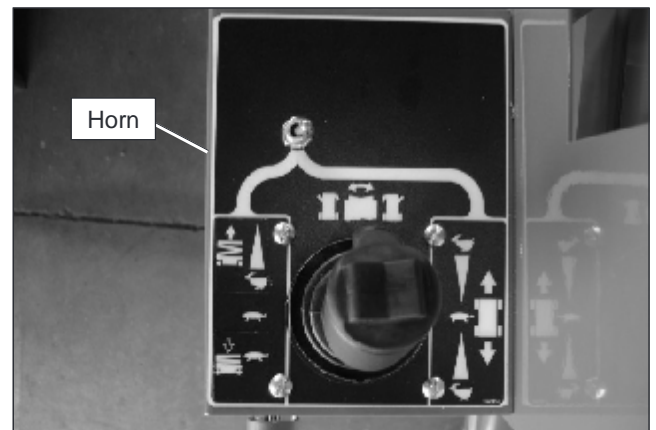

Figure 4.8 – Upper Controls

## Flashing Light

An optional red or amber flashing light may be located at the rear of the aerial platform. The flashing light warns personnel that the aerial platform is in the area.

The light flashes at about one flash per second when the machine is set up for operation from the upper controls.



## Chapter 5 – Gauges and Displays

The aerial platform is equipped with several gauges to monitor the condition of the machine before and during operation.

### Hour Meter

The hour meter is located on the lower control panel (refer to Figure 5.1). It measures the accumulated aerial platform operating time.

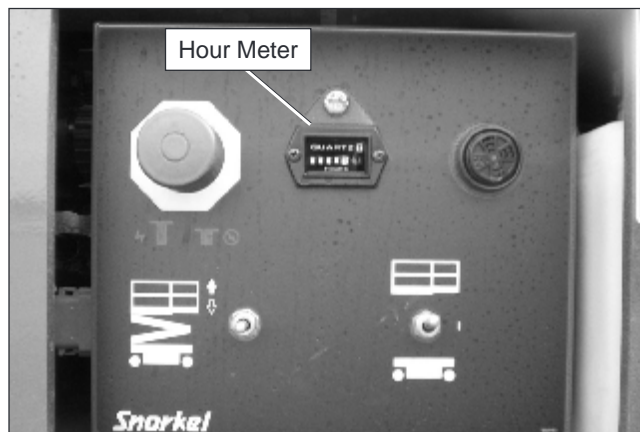

Figure 5.1 – Lower Controls

### Battery Charge Indicator

Some early production S1930E and S1932E have used a Lester charger (refer to Figure 5.2). This charger has four LED's which indicate the charger status.

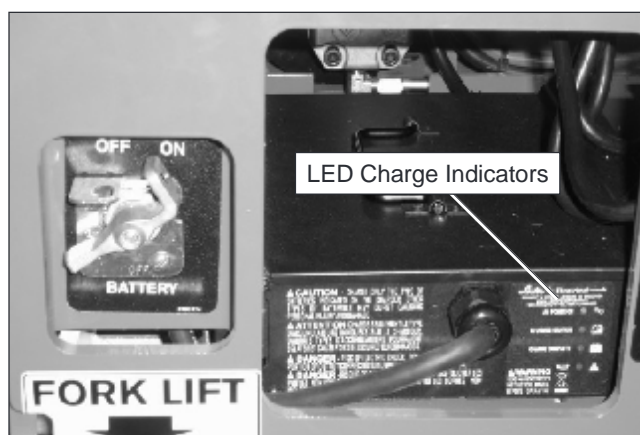

Figure 5.2 – Lester Battery Charger

The LED's are visible on the battery tray.

- AC Power On (Blue) – indicates that AC power is applied to the charger.
- Charge Status (Yellow) – blinks until the batteries are 80% charged and then remains solid from 80% to 100% charge.
- Complete Charge (Green) – lights solid when the batteries are fully charged.

- Fault (Red) – lights solid when there is a battery fault and blinks when there is a charger fault.

Later model S1930E and S1932E's and all S2632E machines use a Signet charger (refer to Figure 5.3). This charger has three LED's which indicate the charger status.

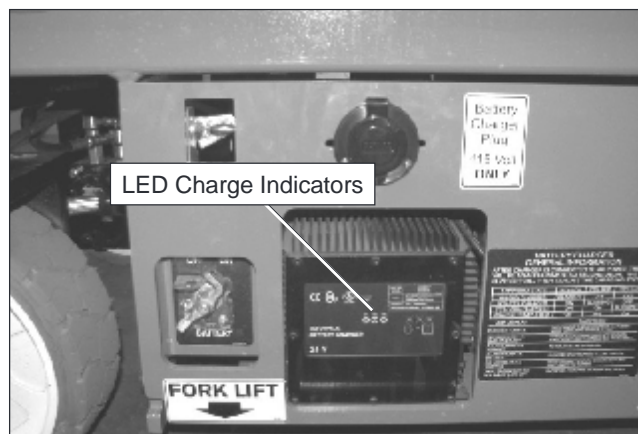

Figure 5.3 – Signet Battery Charger

The LED's are visible on the battery tray.

- 50% LED blinking – indicates that the batteries are 0% to 50% charged.
- 75% LED blinking – indicates that the batteries are 50% to 75% charged.
- 100% LED blinking – indicates that the batteries are 75% to 100% charged.
- All three LED solid On – indicates that the charge cycle is complete.

### Battery Condition Indicator

The optional battery condition indicator (refer to Figure 5.4) is located on the upper control panel. It displays the level of available battery power to operate the aerial platform. The number one on the scale indicates full power and zero indicates no power.

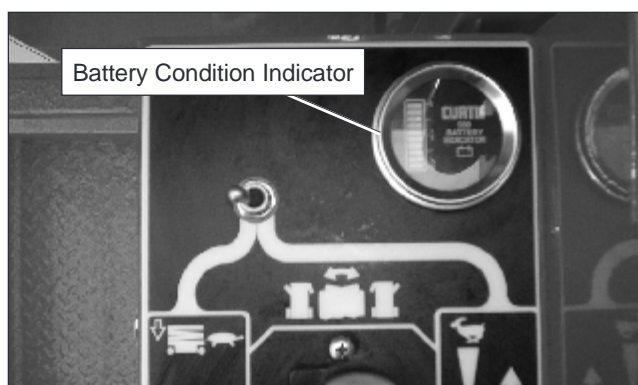

Figure 5.4 – Upper Controls

### Diagnostic Center Display

The diagnostic center LCD display (refer to Figure 5.5) is located in the hydraulic tray next to the fluid reservoir.



Figure 5.5 – Diagnostic Center LCD Display

When the battery disconnect and emergency stop switch are in the on position, the LCD display shows:

- The accumulated aerial platform operating time
- The available battery power to operate the machine.

## Chapter 6 – Batteries

The battery tray contains 4, 220 amp hour, 6 volt batteries. These batteries supply 24 volt DC electrical power to operate the aerial platform drive and platform control systems. Proper machine operation depends on well maintained and charged batteries.

### General Maintenance

Always keep the batteries clean, free of dirt and corrosion. A film on top of the battery can accelerate discharge.

#### **Warning**

Battery acid can damage the skin and eyes. Serious infection or reaction can result if medical treatment is not given immediately. Wear face and eye protection when working near the batteries.

Use distilled water to refill the batteries. Avoid water containing metallic solids such as iron which can reduce the life of the batteries.

Consult a battery charger specialist if extreme temperature use is unavoidable.

Cold reduces battery capacity and retards charging.

Heat increases water usage and can result in overcharging.

Very high temperatures can cause thermal run away which may lead to an explosion or fire.

### Charging

The aerial platform is equipped with an automatic battery charger that will completely recharge the batteries and turn off after the charge cycle is completed.

#### **Warning**

Batteries give off hydrogen and oxygen that can combine explosively. Death or serious injury can result from a chemical explosion. Charge the batteries only in a well ventilated area away from sparks or flame.

#### **Caution**

The batteries can be overcharged and/or damaged if the charger fails to shut off automatically. Do not leave the battery charger on for more than two days.

It may take from 1 1/2 to 16 hours to recharge the batteries depending on the amount of discharge. If the charging cycle exceeds 16 hours without the batteries being fully recharged, shut off the charger and have the batteries checked.

Fully recharge the batteries, immediately after use.

One charging cycle per day is preferred.

Fully charged batteries perform best.

The deeper the discharge, the fewer number of cycles a battery will deliver. Deep discharges deteriorate the battery quicker than light shallow cycles.

An overly discharged battery may need to be cycled a few times before it can fully recover.

If a battery begins to heat before becoming fully charged, it may be necessary to recharge and discharge the battery a few times.

Use the following procedure to charge the batteries.

1. Turn the battery disconnect switch (refer to Figure 6.1) off. The switch is next to the latch on the battery tray.

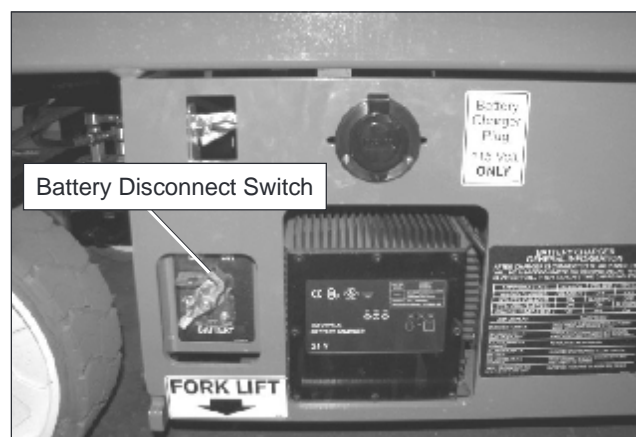

Figure 6.1 – Battery Tray

2. Check the battery water level. Add water to individual cells only if the plates are exposed. Replace the battery caps.
3. Plug the charger into a properly grounded AC outlet using a 3 conductor, 12 gauge or larger extension cord. The extension cord must be as short as possible and in good electrical condition.
4. Leave the charger plugged in until it shuts itself off.
5. Unplug the extension cord after the charger turns itself off. Allow the batteries to cool off after charging.
6. Check the battery water level. Add water to individual cells only if the plates are exposed. Replace the battery caps.



## Chapter 7 – Controls

### **⚠ Danger**

Pinch points may exist between moving components. Death or serious injury will result from becoming trapped between components, buildings, structures, or other obstacles. Make sure all personnel stand clear while operating the aerial platform.

Controls to position the platform are located on the lower control panel on the chassis and on the upper control panel in the platform.

Controls to drive the aerial platform are located on the upper control panel only.

### Battery Disconnect

The battery disconnect is located next to the latch on the battery tray (refer to Figure 7.1).

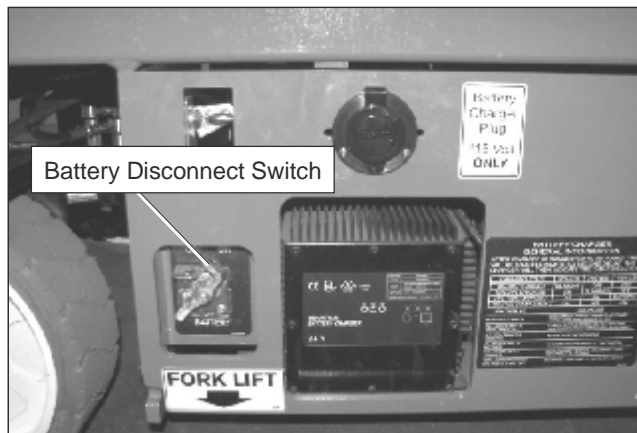

Figure 7.1 – Battery Disconnect Switch

The battery disconnect switch removes electrical power from all electrically controlled functions when in the off position.

Place the switch in the on position to operate any electrically controlled function.

### **⚠ Caution**

Only authorized personnel should operate the aerial platform. Unqualified personnel may cause injury to coworkers or property damage. Lock the battery disconnect switch in the off position before leaving the aerial platform unattended.

Lock the battery disconnect switch in the off position to prevent unauthorized use of the aerial platform.

### Lower Controls

The lower controls (refer to Figure 7.2) are located on the right side of the chassis. Only platform functions can be operated from the lower controls.

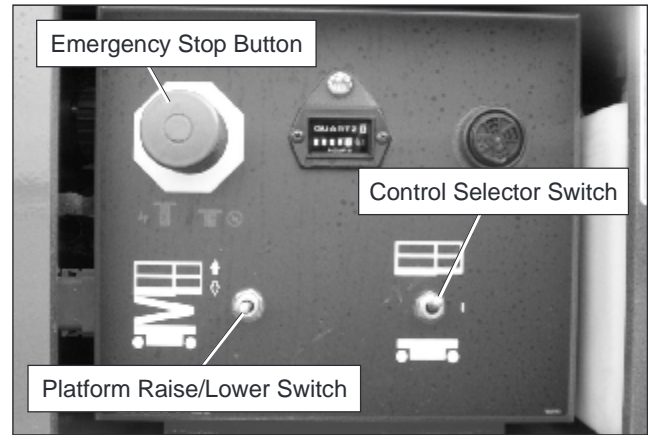

Figure 7.2 – Lower Controls

The following are located on the lower control panel:

- Emergency stop button
- Control selector switch
- Platform raise/lower switch

#### Emergency Stop Button

The emergency stop is a two-position red push button.

Push the button inward to disconnect power to all control circuits.

Pull the button outward to restore power.

#### Control Selector Switch

Insert the key into the control selector switch.

Place the control selector switch in the down position to operate aerial platform functions from the lower controls. The upper controls will not operate while the control selector is in the lower position.

Place the selector switch up in the upper control position to operate the aerial platform functions from the upper controls.

#### Platform Raise/Lower Switch

The platform raise/lower switch is used to raise or lower the platform. The switch is spring returned to the center off position.

Hold the switch upward to raise the platform.

Hold the switch downward to lower the platform.

An alarm will sound as the platform lowers.

## Upper Controls

The upper controls (refer to Figure 7.3) are located on the control panel at the platform. Platform and drive functions can be operated from the upper controls.

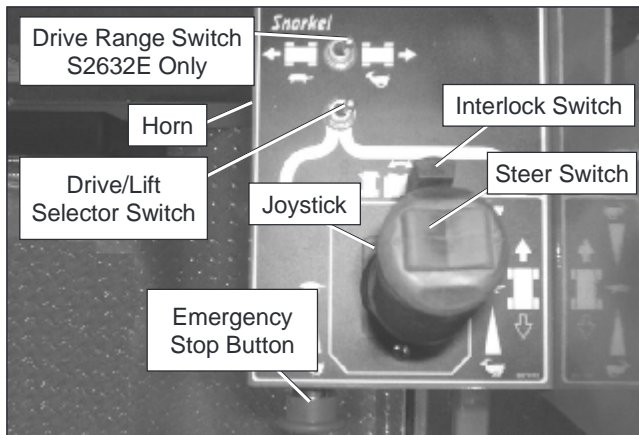

Figure 7.3 – Upper Controls

### Warning

The potential for an accident increases from improperly driving or steering the aerial platform. Death or serious injury could result from such accidents. Make sure the upper control panel is at the front of the platform, hooked on the guardrail, and hanging inside the platform.

Avoid driving the platform with the upper controls facing the rear or side of the machine. In this position the machine is difficult to control because the drive and steer control movements and their resulting machine movements will not correspond.

Only operate the upper controls when the panel is at the front of the platform, hooked on the guardrail inside the platform, and facing the front of the machine (refer to Figure 7.4).

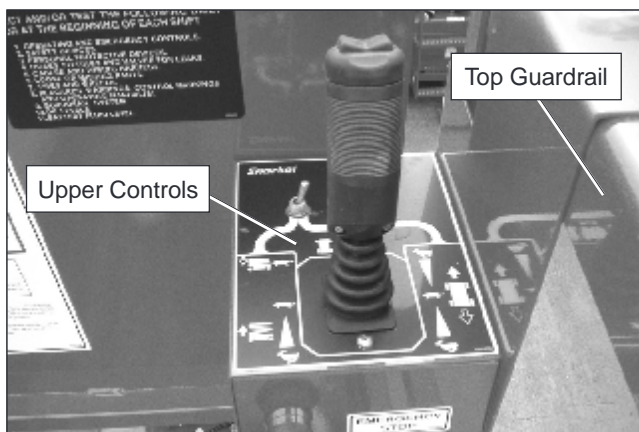

Figure 7.4 – Upper Control Operating Position

The following controls are located on the upper control panel:

- Emergency stop button
- Drive/lift selector switch
- Drive range switch – S2632E only
- Joystick to control platform lift, drive, and steer

The horn button and battery condition indicator gauge may also be located at the upper control station.

### Emergency Stop Button

The emergency stop (refer to Figure 7.3) is a two-position, red push button on the front of the upper control panel.

Push the button inward to disconnect power from all control circuits at the upper controls.

Pull the button outward to restore power.

Push the emergency stop button inward when the upper controls are not in use to protect against unintentional operation.

### Note

The lower controls override the upper controls. If the upper control emergency stop is engaged the lower controls can still be used to operate the aerial platform.

Push the button in when the upper controls are not in use to help protect against unintentional platform operation.

### Drive/Lift Selector Switch

The drive/lift selector switch (refer to Figure 7.3) is used to select either machine drive or lift functions. Both functions can not be operated at the same time.

Place the drive/lift selector switch in the drive position to drive the aerial platform using the joystick. The platform will not raise or lower while driving.

Place the drive/lift selector switch in the lift position to raise and lower the platform using the joystick.

### Joystick

Use the joystick (refer to Figure 7.3) to operate the following functions:

- Aerial platform steering
- Aerial platform drive and speed
- Platform raise/lower and speed

Movement of the joystick in a given direction produces a corresponding movement of the aerial platform. The steering and drive functions may be operated separately or simultaneously.



### Interlock Switch

The joystick has an interlock switch in the handle (refer to Figure 7.3).

Engage the interlock by grasping the joystick and pulling the switch toward the handle.

Engage the interlock to activate the steering, drive, or lift functions.

### Steer Switch

The steer switch (refer to Figure 7.3) is a momentary contact, rocker switch on top of the drive joystick. This switch controls the two front wheels to steer the aerial platform.

To steer to the right, engage the interlock switch on the joystick and hold down the right side of the steer switch.

To steer to the left, engage the interlock switch on the joystick and hold down the left side of the steer switch.

### Note

The steering wheels are not self-centering. Set the steering wheels straight ahead after completing a turn.

### Drive Range Switch – S2632E Only

The drive range switch has two positions to select drive wheel operation:

High (Rabbit) – for normal driving conditions

Low (Turtle) – for driving on grades up to 25 percent that require low speed and high torque operation, where high range is not sufficient to climb the grade.

### Horn Button

The horn button (refer to Figure 7.3) is on the left side of the upper control panel.

Press the button to sound the horn.

### Battery Condition Indicator

The optional battery condition indicator gauge is on the top of the upper control box. It indicates the level of available battery power to operate the aerial platform.

### Circuit Breaker Reset Button

The electrical power outlet at the platform has a 15 amp circuit breaker. The reset button is on the bottom of the electrical box. The circuit breaker protects the electrical wiring and components from electrical overload in the case of a short circuit or other fault.

### Caution

A tripped circuit breaker indicates a malfunction in the electrical system. Component damage can result if the cause of the malfunction is not corrected. Do not operate the aerial platform if the circuit breaker trips repeatedly.

Push the reset button to reset the circuit breaker.



## Chapter 8 – Prestart Inspection

Potential service and safety problems may be detected by inspecting the aerial platform. This chapter includes information on properly inspecting the aerial platform and includes a prestart inspection check list at the end of this chapter to ensure that no areas are overlooked.

### ⚠Warning

The potential for an accident increases when operating an aerial platform that is damaged or malfunctioning. Death or serious injury could result from such accidents. Do not operate the aerial platform if it is damaged or malfunctioning.

Perform a prestart inspection at the beginning of each shift, before using the aerial platform on the job. The inspection site must have a smooth and level surface.

### Operator's Manual

The manual holder is located at the front of the platform (refer to Figure 8.1).

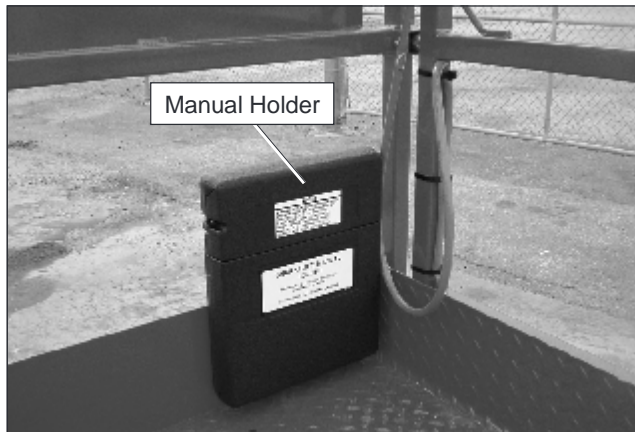

Figure 8.1 – Operator's Manual Holder

To inspect the operator's manual and manual holder:

1. Make certain the Operator's Manual holder is securely fastened in place.
2. Check to see that the proper Operator's Manual is in the holder.
3. Check to see that the manual is complete with all pages intact and in readable condition.
4. Make certain ANSI publication "Manual of Responsibilities for Dealers, Owners, Users, Operators, Lessors and Lessees of ANSI/SIA A92.6-2006 Self-Propelled Elevating Work Platforms" is in the manual holder.

### Electrical System

Electrical power is supplied from four 220 amp hour, 6 volt batteries. The batteries supply 24 volt DC electrical power to operate the aerial platform drive and control

system. The batteries are in the swing-out tray on the left side of the aerial platform.

### ⚠Warning

Batteries give off hydrogen and oxygen that can combine explosively. Death or serious injury could result from a chemical explosion. Do not smoke or permit open flames or sparks when checking the batteries.

### ⚠Caution

Even with low voltage electrical systems, severe arcing can occur. Electrical shock or component damage may result from contact with energized conductors. Use caution when working with any electrical device.

For optimal battery performance the battery fluid level must be maintained and the battery connections must be kept clean.

### Battery Fluid Level

To inspect the battery fluid level:

1. Remove the caps from the batteries (refer to Figure 8.2).

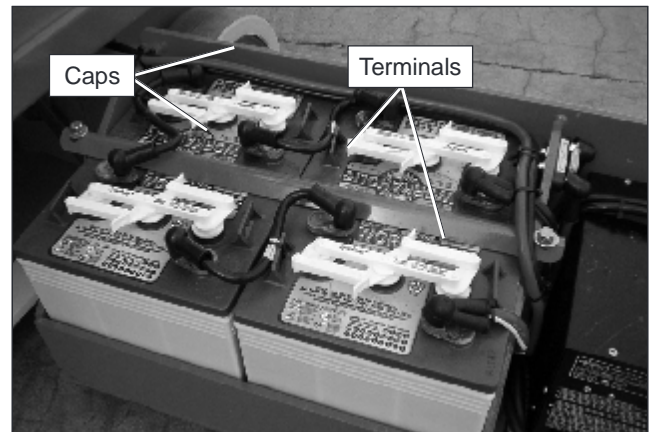

Figure 8.2 – Battery Tray

2. Visually check the battery fluid level making sure the level is ¼" (6 mm) above the plates.
3. If necessary, add distilled water.

### Note

Use only distilled water when recharging the battery. Tap water may contain metallic solids such as iron which can reduce the life of the battery.

4. Replace the caps on the battery. The caps must be in place and tight during machine operation and battery charging.

### Battery Terminals

To inspect the battery terminals:

1. Check the top of the battery, the terminals, and cable ends (refer to Figure 8.2). They should be clean and free of corrosion.
2. If necessary, clean the top of the battery. Clean the terminals and cable ends with a wire brush or terminal cleaning tool.
3. Make sure all cable ends are securely fastened to the terminals.

### Battery Charger

Inspect the battery charger (refer to Figure 8.3) to ensure that it is operating properly.

1. Turn the battery disconnect switch off.
2. Plug the charger into a source of power.
3. Observe the LED's on the charger to determine the charger status. If necessary, refer to the charger decal or to Battery Charge Indicator in Chapter 5 to determine when the batteries are fully charged.

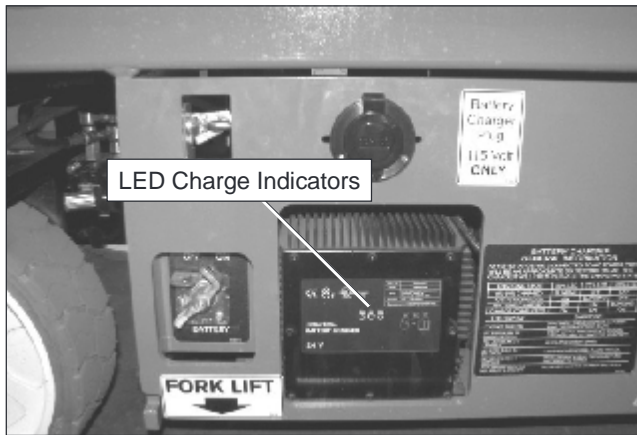

Figure 8.3 – Battery Charger

4. Unplug the charger.

### Safety Prop

Always use the safety prop when the platform is raised before inspecting or performing service or maintenance procedures on the machine.

#### Danger

Pinch points exist on the scissors structure. Death or serious injury will result if the scissors structure drops onto personnel working within the scissors arms or under the raised platform. Properly position the safety prop before reaching through the scissors structure.

Use the following procedure to properly position the safety prop:

1. Remove all tools and material from the platform.
2. Using the lower controls, raise the platform until the open height between the arm pins is wide enough to position the safety prop.
3. Rotate the safety prop downward from the storage position to the support position (refer to Figure 8.4).



Figure 8.4 – Safety Prop

4. Remove hands and arms from the scissors structure area.
5. Lower the platform until the scissors are supported by the safety prop.

Use the following procedure to stow the safety prop:

1. Using the lower controls, raise the platform until the open height between the arm pins is wide enough to move the safety prop.
2. Rotate the safety prop upward to the stowed position (refer to Figure 8.5).



Figure 8.5 – Safety Prop

- Using the lower controls completely lower the platform.

### Cables and Wiring Harness

To inspect the cables and wiring harness:

- Visually inspect all cables and wiring for wear and/or physical damage such as loose connections, broken wires, and frayed insulation.
- Check the wiring in areas where a change in routing direction may cause them to become pinched.
- Make sure the cables and wires are properly routed to avoid sharp edges, pinching, and scuffing.

### Hydraulic System

Hydraulic power is supplied from a single stage hydraulic pump with a 4.25 horsepower DC electric motor.

#### ⚠ Danger

Hydraulic fluid escaping under pressure can have enough force to inject fluid into the flesh. Serious infection or reaction will result if medical treatment is not given immediately. In case of injury by escaping hydraulic fluid, seek medical attention at once.

The hydraulic reservoir, pump, filter, and control valve are located in the hydraulic tray on the right side of the chassis.

#### Fluid Level

To inspect the fluid level:

- Make sure the aerial platform is fully stowed on a level surface.
- The fluid level must be between the add and full marks (refer to Figure 8.6).



Figure 8.6 – Hydraulic Tray

#### ⚠ Caution

Not all hydraulic fluid is suitable to use in the hydraulic system. Some have poor lubricating characteristics and may increase component wear. Only use hydraulic fluid as recommended.

- If necessary, add fluid of the proper type.

#### Note

Refer to Chapter 2 for the proper type and grade of hydraulic fluid to use. The need to regularly add fluid indicates a leak that should be corrected.

- Replace the cap making sure it is tightly in place.

#### Hoses, Tubes, and Fittings

To inspect the hoses, tubes and fittings:

- Inspect all hydraulic hoses, tubes, and fittings for wear, leakage, or damage (refer to Figure 8.7).



Figure 8.7 – Hoses, Tubes, and Fittings

- Make sure the hoses are properly routed to avoid sharp edges, kinking, and scuffing.
- Inspect the tubes for dents or other damage that may restrict fluid flow.
- Make sure all hoses and tubes are held firmly in their support brackets.
- Check under the chassis for fluid that has leaked. Hydraulic fluid leaks are easily visible on the ground.

#### Free-Wheeling Valve

Check the free-wheeling valve to make sure it is fully closed (clockwise).

S1930E and S1932E – the free-wheeling valve is on the hydraulic manifold in the hydraulic tray (refer to Figure 10.3, page 44).

S2632E – the free-wheeling valve is at the rear of the chassis, inside the step (refer to Figure 10.5, page 44).

### Tires and Wheels

Visually inspect the tires and wheels (refer to Figure 8.8) to make sure they are suitable for service.



Figure 8.8 – Tires and Wheels

To inspect the tires and wheels:

1. Visually inspect the tires. They should be smooth without any cuts, gouges, or missing rubber that might affect aerial platform stability.
2. Check the wheels to see that the fasteners are in place and are not damaged or loose.

### Ground Strap

Make certain the ground strap (refer to Figure 8.9) is securely fastened to the chassis. It should be long enough to contact the ground surface to eliminate static electricity from the machine.

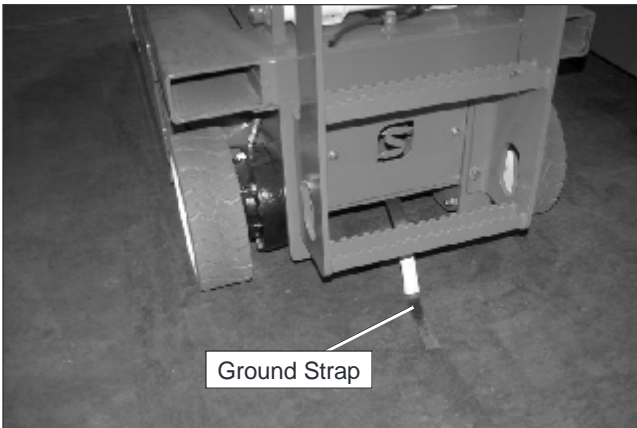

Figure 8.9 – Rear of Chassis

### Lower Control Station

With no personnel or materials in the platform, test the operation of each control from the lower controls (refer to Figure 8.10).

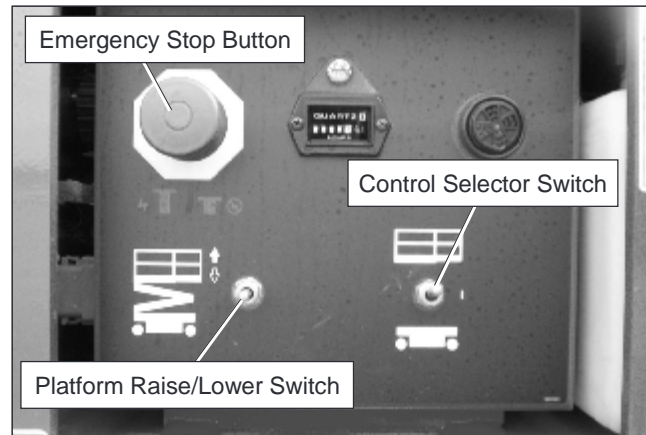

Figure 8.10 – Lower Controls

### Operating Controls

Use the following procedure to operate and test the machine from the lower controls:

1. Turn the battery disconnect switch on.
2. At the lower controls, pull the emergency stop switch outward to the on position.
3. Place the controls selector downward in the lower controls position.

### **⚠ Danger**

Pinch points may exist between moving components. Death or serious injury will result from becoming trapped between components, buildings, structures, or other obstacles. Make sure all personnel stand clear of the aerial platform while performing the prestart inspection.

### **⚠ Warning**

The potential for an accident increases when operating an aerial platform that is damaged or malfunctioning. Death or serious injury could result from such accidents. Do not operate the aerial platform if it is damaged or malfunctioning.

4. Test the operation of the platform raise/lower switch in both directions.
5. Place the battery disconnect switch in the off position. The platform should not raise or lower with the disconnect in this position.

### Emergency Stop

To test the emergency stop button from the lower controls:

1. Push the emergency stop button inward to turn off electrical power.
2. Test the lower control functions to make sure they do not operate with the emergency stop in this position.

### Lowering Alarm

To test the lowering alarm from the lower controls:

1. Raise the platform approximately 10' (3 m).
2. Lower the platform and make sure the alarm sounds.

### Pothole Protector Interlock

Perform this test using the lower controls.

1. Stow the aerial platform on a smooth, flat, level concrete slab.
2. Remove all persons and materials from the platform.
3. With the trays closed, check the ground clearance under the pothole protector skids (refer to Figure 8.11). Clearance should be at about 2 1/2" (6.3 cm) on both sides of the aerial platform.

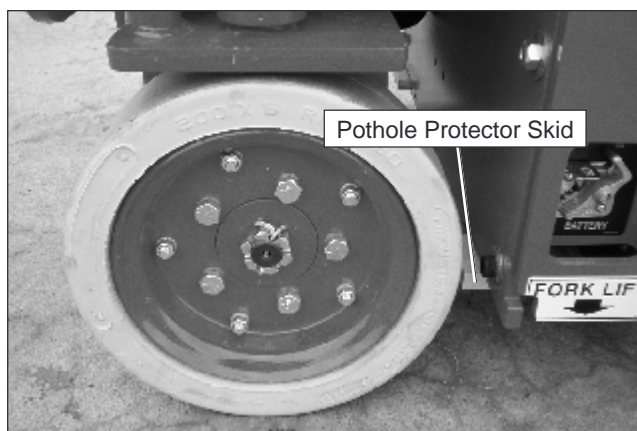

Figure 8.11 – Pothole Protector Skid

4. Raise the platform while watching movement of the skids. The skids should lower to approximately 3/4" (2 cm) ground clearance when the platform is raised approximately 24" (61 cm).
5. Fully lower the platform while watching movement of the skids. The skids should raise to their stowed position, with about 2 1/2" (6.3 cm) ground clearance when the platform is fully lowered.
6. Place a 1 1/2" (3.8 cm) thick board, such as a 2 x 4, under the skid on the left side (refer to Figure 8.12).

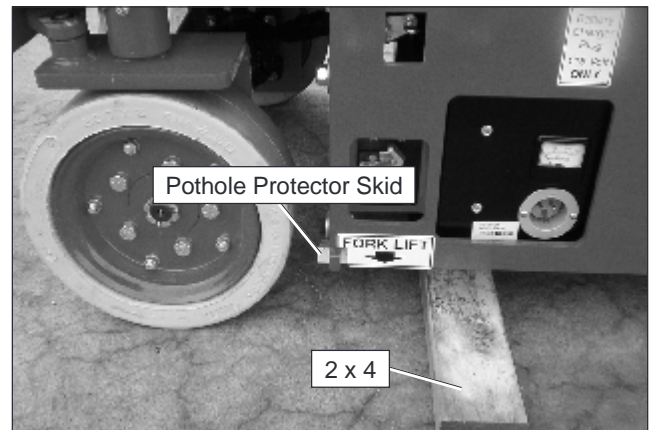

Figure 8.12 – Pothole Protector Skid

7. The board will prevent the skid from lowering fully. Raise the platform. When the skid contacts the board, the platform should stop raising and an alarm should sound at approximately 7' (2 m) platform floor height. The alarm should then sound when the platform lift switch is activated and the platform should not raise.
8. Lower the platform. Place the board under the skid on the right side.
9. Raise the platform. When the skid contacts the board, the platform should stop raising and an alarm should sound at approximately 7' (2 m) platform floor height. The alarm should then sound when the platform lift switch is activated and the platform should not raise.

### Warning

The potential for an accident increases when safety devices do not function properly. Death or serious injury can result from such accidents. Do not alter, disable, or override any safety device.

10. If the platform raise function is not disabled, or the alarm does not sound remove the aerial platform from service until the problem is corrected.

### Emergency Lowering System

Use the following procedure to test the emergency lowering system:

### Danger

Pinch points may exist between moving components. Death or serious injury will result from becoming trapped between components. Stand clear of moving components while test operating the machine.

1. Use the lower controls, fully raise the platform. Push the emergency stop button inward.
2. Locate the emergency lowering control. On S1930E and S1932E machines the lowering lever is at the front of the aerial platform. On S2632E machines a

handle at the rear of the chassis is used for emergency lowering (refer to Figure 8.13).

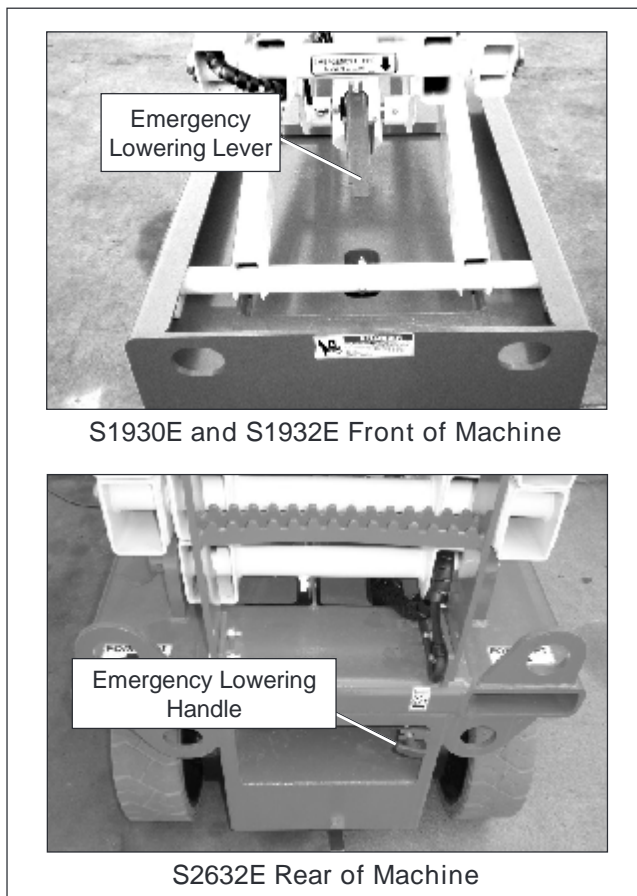

Figure 8.13 – Emergency Lowering Control

**⚠ Danger**

Pinch points may exist between moving components. Death or serious injury will result from becoming trapped between components. Make sure all personnel stand clear while lowering the platform with the emergency lowering lever.

3. Make sure there is nothing in the way to obstruct the platform when it lowers.
4. While standing clear of the scissors structure, engage the control. The platform will begin to lower as the lever is pushed down.

S1930E and S1932E machines – push downward on the lever to lower the platform.

S2632E machines – pull outward on the handle to lower the platform.

5. Release the lever/handle to stop the platform from lowering.

**Structures**

Visually inspect all weldments and related components. It is important to inspect the fasteners that connect the components.

**Weldments**

To inspect the weldments:

1. Visually inspect all weldments for abnormal wear, abrasion, or deformation that could cause interference between moving parts.
2. Inspect the welds on the structural components. The area to be inspected should be clean and free of dirt and grease.
3. Look for visible cracks in the welds and at the weld to parent material joints. A bright light may be used to provide adequate visibility of the inspection area.
4. Pay close attention to welds in areas where changes in cross section take place and near the attachment points of highly loaded components.

**Slide Blocks**

To inspect the slide blocks:

1. Visually inspect the scissors arm slide blocks (refer to Figure 8.14). They must be free to move without obstruction. There is one slide block on each side of the chassis.

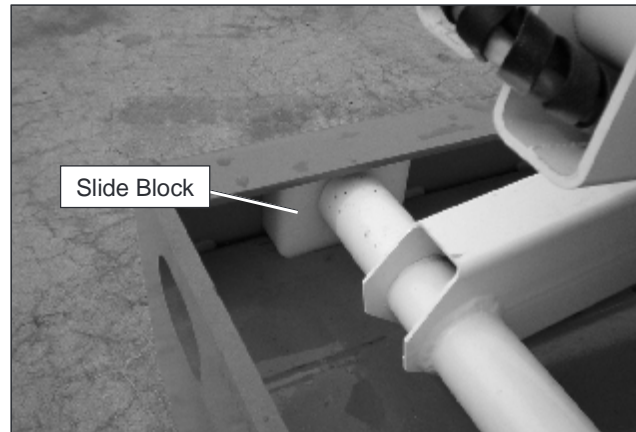

Figure 8.14 – Front of Chassis

2. Raise the platform from the lower controls and visually inspect the slide blocks underneath the front of the platform (refer to Figure 8.15). There is one slide block on each side of the platform. The slide blocks must be in good condition and free to move without obstruction.



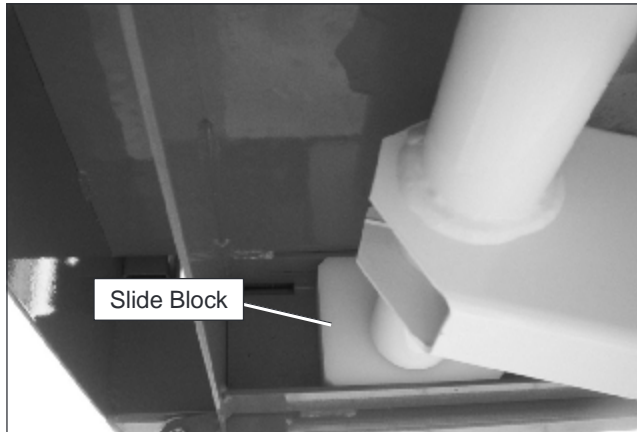

Figure 8.15 – Front of Platform

#### Fasteners

To inspect the fasteners:

1. Visually inspect all fasteners to see that none are missing or loose.
2. Inspect all of the bolts, nuts, rollpins, collars, and snap rings. They should all be present, tight, and not damaged in any way.

#### Upper Control Station

Inspect the platform and upper controls only if all functions operated properly from the lower controls.

#### Guardrail System

The guardrail system includes (refer to Figure 8.16):

- A top rail
- A mid rail
- An entry gate
- A wallboard loading gate
- Toeboards around the sides of the platform.

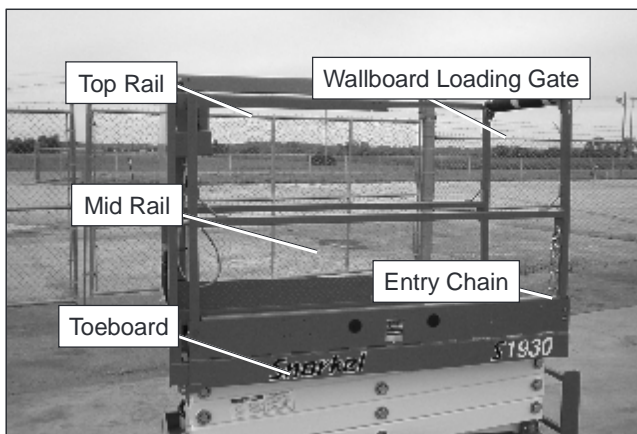

Figure 8.16 – Upper Controls

To inspect the guardrail system:

1. Visually inspect all components of the guardrail system. Make sure the rails and toeboards are all in place and free of any damage or deformation.
2. Visually check the rail and toeboard welds for cracks.
3. Visually check all bolts and nuts fastening the platform and guardrails in place. They must be present and not show any signs of looseness.
4. Inspect the wallboard loading gate and entry gate to see that they are present, swing freely, close firmly, and are not deformed in any way. Make sure the gates are secure when they are closed.

#### Platform Extension

A foot lever on the right side of the platform secures the extension deck to the main platform deck.

#### ⚠Caution

The extension deck is free to move when the foot lever is depressed. Personal injury may result from accidentally extending or retracting the deck. Make certain the pin is engaged when the deck is extended in the working position and when it is stowed. Do not attempt to extend or retract the platform unless the aerial platform is on a level surface.

To inspect the platform extension:

1. Inspect the foot lever (refer to Figure 8.17) to ensure that it releases the pin to extend the platform.

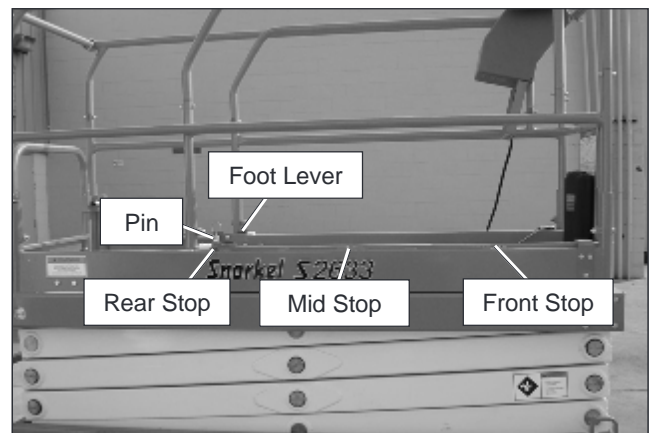

Figure 8.17 – Platform Extension

2. While facing the front of the platform, step down on the foot lever and push the top rail of the extension deck forward until the pin engages the mid or front stop.
3. Inspect the rollers on the platform extension. They must be in place, in good condition, and free to move without obstruction.

4. Inspect the weldments for deformation and damage. Try to move the rails back and forth to make sure the platform extension deck is locked in position.
5. Visually check the platform welds for cracks.
6. While facing the front of the platform, depress the foot lever and grasp the top rail of the extension deck. Pull backward to retract the deck until the pin engages the rear stop (refer to Figure 8.17).
7. Make sure the platform extension deck is locked in position.

**Fold Down Rails**

Inspect the pins that hold the rails in position (refer to Figure 8.18) to make sure they are in place and are not deformed. There is one pin on each vertical side rail, the entry gate, the front panel and one that fastens the upper controls to the platform rails.

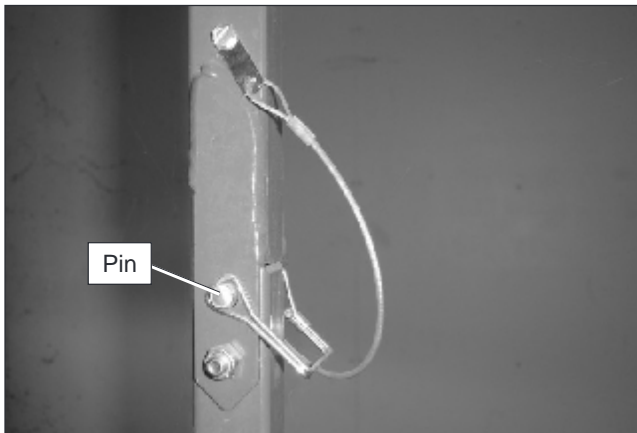

Figure 8.18 – Fold Down Rails Pin

**Operating Controls**

**⚠Warning**

The potential for an accident increases from improperly driving or steering the aerial platform. Death or serious injury could result from such accidents. Make sure the upper control panel is at the front of the platform, hooked on the guardrail, and hanging inside the platform.

Avoid driving the platform with the upper controls facing the rear or side of the machine. In this position the machine is difficult to control because the drive and steer control movements and their resulting machine movements will not correspond.

Only operate from the upper controls when it is at the front of the platform, hooked on the guardrail, and hanging inside the platform facing the front of the platform.

Use the following procedure to operate and test the machine from the upper controls:

1. Make sure the battery disconnect is turned on.
2. At the lower controls, pull the emergency stop button outward.
3. Place the control selector switch upward in the upper control position.
4. At the upper controls (refer to Figure 8.19), pull the emergency stop button outward.

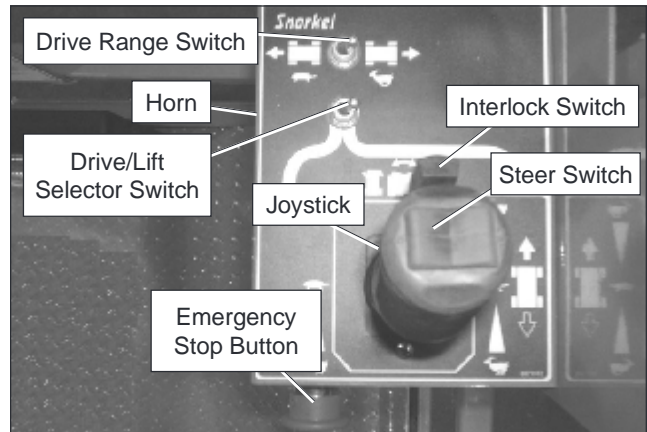

Figure 8.19 – Upper Controls

**⚠Warning**

The potential for an accident increases when operating an aerial platform that is damaged or malfunctioning. Death or serious injury could result from such accidents. Do not operate the aerial platform if it is damaged or malfunctioning.

5. Test the interlock switch by moving the joystick without engaging the interlock switch.

If movement occurs the interlock is not functioning properly. Do not operate the machine until the problem is corrected.

6. Place the drive/lift selector switch in the drive position and test the operation of the joystick in both directions. The lift functions should not operate with the selector in the drive position.

Squeeze and hold the interlock switch against the joystick. Test the steer switch in both directions using the steering switch.

To steer to the right, hold down the right side of the steer switch.

To steer to the left, hold down the left side of the steer switch.

7. Test the operation of the brakes while operating the aerial platform from the upper controls. The brakes are engaged when:

the joystick interlock is released.

the drive/lift selector switch is in the lift position.

the emergency stop button is pushed down.

Placing the drive/lift selector in the drive position, engaging the interlock and moving the joystick, releases the brakes.

8. Place the drive/lift selector switch in the lift position and test the operation of the joystick in both directions. The drive functions should not operate with the selector in the lift position.

Squeeze and hold the interlock switch against the joystick. Test the joystick in both directions.

To raise the platform push the joystick forward.

To lower the platform pull the joystick backward.

#### Emergency Stop

To test the emergency stop button from the upper controls:

1. Push the emergency stop button inward to turn off electrical power.
2. Verify that the upper control platform and drive functions do not operate.

#### Horn Button

The horn is operational when the machine is set up for operation from the upper control panel (refer to Figure 8.19).

Press the horn button to ensure that it sounds to warn personnel in the area.

#### Lowering Alarm

To test the lowering alarm from the upper controls:

1. Raise the platform approximately 10' (3 m).
2. Lower the platform and make sure the alarm sounds.

#### Drive Alarm

The machine may be equipped with a drive alarm.

Drive in both the forward and reverse directions to ensure that the alarm sounds to warn personnel in the area that the aerial platform is in motion.

#### Electrical Power Outlet

Connect a source of 125 volt AC power to the power-input connector at the rear of the chassis. Plug an electrical tool into the receptacle and try to operate the tool to verify proper operation of the outlet.

Use the following procedure to test the ground fault circuit interrupter GFCI.

1. Push the test button (refer to Figure 8.20).

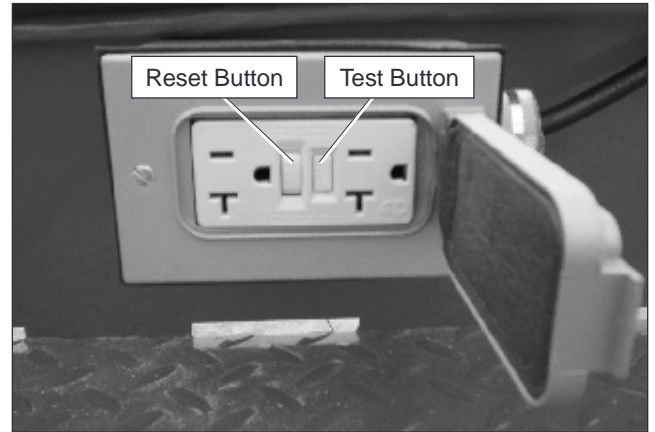

Figure 8.20 – Electrical Power Outlet

2. Plug an electrical tool into the outlet and verify the power is off.

If the power was off, push the reset button to restore power.

If the power was on, repair or replace the receptacle.

#### Flashing Light

The machine may be equipped with an optional flashing light mounted on the side of the machine.

To inspect the flashing light:

1. At the lower controls, pull the emergency stop button outward and turn the control selector switch to either the lower or upper control position.
2. Operate any control function and visually check to see that the light is flashing approximately one flash per second.

#### Note

There is not an off switch for the flashing light.

#### Battery Condition Indicator

The optional battery condition indicator (refer to Figure 8.21) is located on the upper control panel.

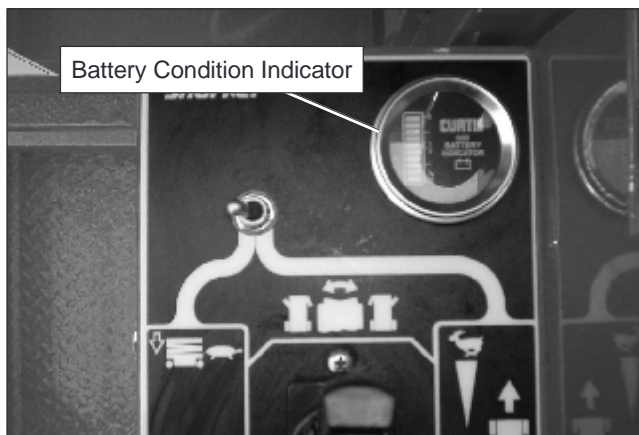

Figure 8.21 – Upper Controls

With the machine set up to operate from the upper controls, check to see that the battery condition indicator gauge displays a power reading.

## Placards and Decals

To inspect the placards and decals:

1. Inspect all safety and operational placards and decals. Make certain they are in place, in good condition, and are legible.
2. Clean the placards and decals with soap and water, and a soft cloth if the words or pictures cannot be seen.

### Caution

Solvents may contain hazardous ingredients. Follow the manufacturer's label for proper use and disposal. Wear protective gloves and splash-proof safety glasses when using solvents.

3. Remove wet paint overspray with a natural biodegradable solvent and a soft cloth.
4. Replace any missing, damaged, or illegible placards or decals before operating the aerial platform.

Placard and decal kits are available from Snorkel.

The safety related placards and decals are illustrated on the following pages.

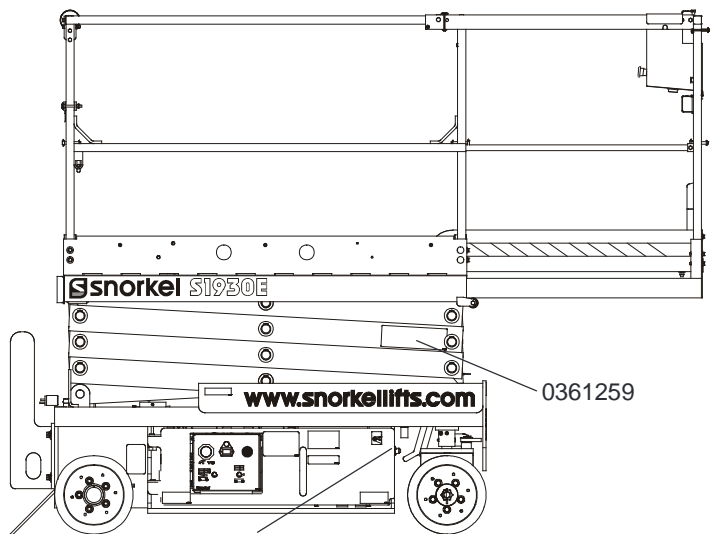

0070901  
(Inside Hydraulic Tray)

Right Side

**⚠ DANGER**

Proper position for safety prop use:

Death or serious injury might result if safety prop is not used and/or properly positioned. Use safety prop at all times when servicing machine with platform raised.

**PROPER USE OF SAFETY PROP**

1. Remove all material from platform.
2. Raise platform until the open height is wide enough to position the safety prop.
3. Place safety prop in the proper position.
4. Remove hands and arms from scissors area.
5. Lower platform until scissors are supported by safety prop.

**TO STORE SAFETY PROP**

1. Raise platform until the open height is wide enough to position the safety prop.
2. Place the safety prop in the storage position.

0361259

**⚠ CAUTION**

Do not remove any weight from this machine. Any weight added must be distributed equally on each side.

Axle weights with machine in the stowed position:

STEER AXLE	lbs	kg
DRIVE AXLE	lbs	kg

0070901

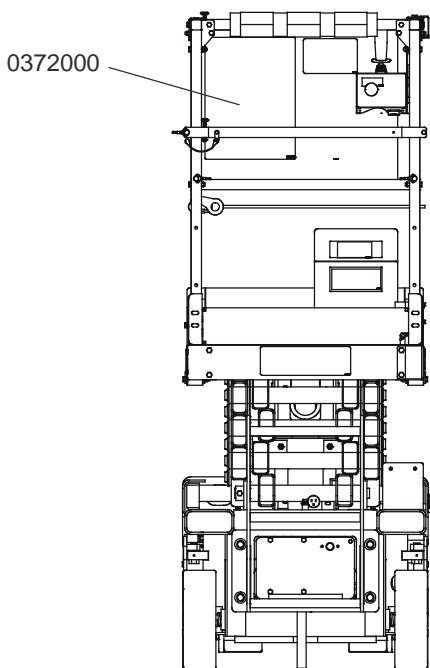

Rear

**⚠ DANGER**

DEATH OR SERIOUS INJURY CAN RESULT FROM TIPPING OVER. TO KEEP FROM TIPPING THIS MACHINE OVER FOLLOW THESE RULES.

**DO NOT RAISE OR DRIVE AN ELEVATED PLATFORM ON A SLOPE.**

**DO NOT RAISE OR DRIVE AN ELEVATED PLATFORM ON SOFT OR UNFIRM SURFACES.**

**DO NOT CLOSER THAN 4 feet (1.2m) to ANY DROP OFF OR HOLE.**

**DO NOT RAISE THE PLATFORM IN WIND ABOVE 25 MPH (12.5 M/S).**

OTHER ACTIONS CAN ALSO CAUSE THIS MACHINE TO TIP OVER:

- DO NOT override safety devices.
- DO NOT use ladders, scaffolds, or other means to increase size or platform height.
- DO NOT use with damaged tires or wheels.
- DO NOT overload the machine.
- DO NOT ride platform while machine is on a truck, bunk lift or other device.
- DO NOT use with damaged tires or wheels.
- DO NOT carry loads outside the rating or use as a crane.

**ALARM MEANS TIPPING DANGER! LOWER PLATFORM IMMEDIATELY**

**OK TO AVOID TIPPING HAZARDS USE ON FLAT, LEVEL AND SOLID SURFACES ONLY**

**ELECTRICAL SHOCK CAN KILL YOU**

This machine is not electrically insulated. Maintain 12" bare minimum clearance from electrical power lines and apparatus.

Allow for platform sway, rock, or sag. If voltage is 300 V to 50 kV stay at least 10 feet (3 m) away. If voltage is more than 50 kV talk with your supervisor or read the Operator's Manual on this machine for safe distances.

DO NOT use this machine without the ratings and this empty gate, chain or bar in place. You could fall and hurt or kill yourself.

DO NOT use this machine if it is not working right, or if any part of it is damaged, worn, or missing. An accident could cause injury or death.

DO NOT let an untrained or unauthorized person use this machine. When you leave the machine unattended, remove the key, or turn off the battery switch on the base of the machine and lock the battery switch in the off position.

DO NOT replace components critical to machine stability, such as batteries and wheel equipment, with lighter weight or

NOTE: STUDY THE OPERATOR'S MANUAL BEFORE OPERATING THIS MACHINE.

0372000

S1930E/S1932E/S2632E – 1360460

33

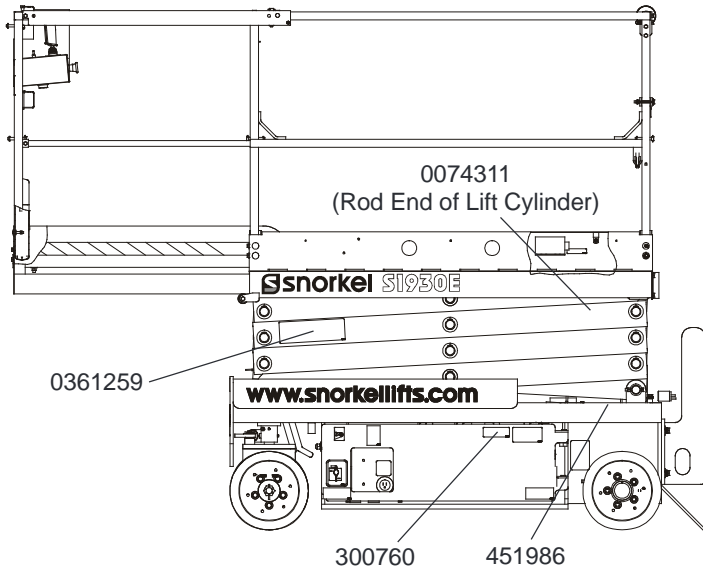

Left Side

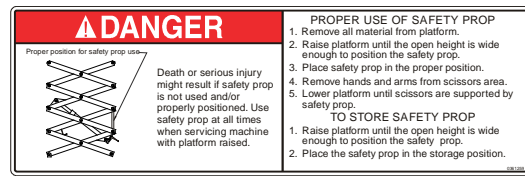

0361259



451986

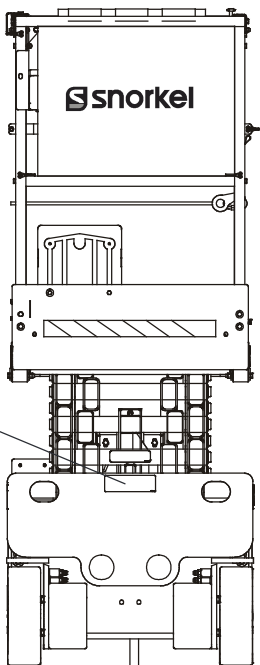

Front



0074311



300760



300700

## Prestart Inspection Checklist

Item	Inspect For	OK
Operator's Manual	In manual holder, all pages readable and intact	
Electrical System		
Battery fluid level	Proper level	
Battery terminals	Clean, connectors tight	
Battery charger	Proper operation	
Cables and wiring harness	No wear or physical damage	
Hydraulic System		
Fluid level	Between full and add marks with platform stowed	
Hoses, tubes and fittings	No leaks, all fittings tight	
Free-wheeling valve	Fully closed	
Tires and Wheels	Good condition	
Ground Strap	In place and securely fastened	
Lower Control Station		
Operating controls	Proper operation	
Emergency stop	Shuts off lower controls/proper operation	
Lowering alarm	Sounds when platform lowers	
Pothole Protection Interlock	Proper operation	
Emergency Lowering	Proper operation	
Safety Prop	No damage or deformation	
Flashing Light	Proper operation	
Structures		
Weldments – Chassis, platform, etc.	Welds intact, no damage or deformation	
Slide blocks	In place, no damage or deformation	
Fasteners	In place, tight, and no damage	
Upper Control Station		
Guardrail system	Welds intact, no damage or deformation All fasteners in place, no loose or missing parts	
Platform extension	Proper operation, no damage or deformation	
Fold down rails	Fasteners in place, proper operation	
Brakes	Proper operation	
Operating controls	Proper operation	
Emergency stop	Shuts off upper controls	
Lowering alarm	Sounds when platform lowers	
Drive motion alarm	Sounds when aerial platform drive function is operated	
Battery condition indicator	Proper operation	
Horn	Sounds when activated	
Placards and Decals	In place and readable	





## Chapter 9 – Operation

The aerial platform may be operated from either the lower or upper controls.

### **⚠ Danger**

The aerial platform is not electrically insulated. Death or serious injury will result from contact with, or inadequate clearance from, an energized conductor. Do not go closer than the minimum safe approach distance as defined by ANSI.

Pinch points may exist between moving components. Death or serious injury will result from becoming trapped between components, buildings, structures, or other obstacles. Make sure there is sufficient clearance around the machine before moving the chassis or platform. Allow sufficient room and time to stop movement to avoid contact with structures or other hazards.

The aerial platform can tip over if it becomes unstable. Death or serious injury will result from a tip-over accident. Operate the aerial platform on a firm, flat, level surface. Avoid travel speeds and/or rough terrain that could cause sudden changes in platform position. Do not drive or position the aerial platform for elevated use near any drop-off, hole, slope, soft or uneven ground, or other tip-over hazard. Do not raise the platform in wind speeds above 28 mph (12.5 m/s).

The platform rated work load is the total weight of the personnel and equipment that may be lifted in the platform.

The work loads are stated on the platform rating placard at the entrance to the platform.

### **⚠ Danger**

The aerial platform can tip over if it becomes unstable. Death or serious injury will result from a tip-over accident. Do not exceed the capacity values indicated on the platform rating placard.

Capacity values indicate the rated lifting capacity and do not indicate aerial platform stability.

The operator bears ultimate responsibility for ensuring that the aerial platform is properly set up for the particular conditions encountered.

### Preparing for Operation

Use the following procedure to prepare the aerial platform for operation:

1. Perform a prestart inspection (refer to Chapter 8).
2. Close and latch the battery and hydraulic trays.
3. Place the battery disconnect switch in the on position.

### Lower Controls

Only the platform raise and lower functions may be operated from the lower controls. The lower controls may be used for initial set up of the aerial platform, and for testing and inspection.

Use the following procedure to raise or lower the platform using the lower controls.

1. Pull the emergency stop button outward (refer to Figure 9.1).

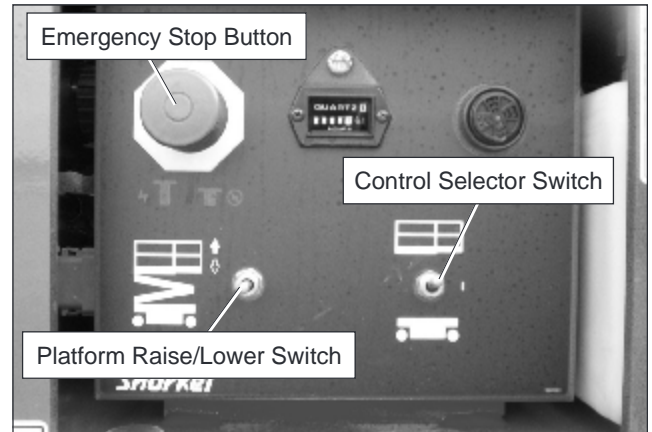

Figure 9.1 – Lower Controls

2. Place the controls selector downward in the lower controls position.
3. Hold the platform raise/lower toggle switch up to raise the platform and down to lower it.
4. Release the toggle switch to stop movement.

### Upper Controls

The upper controls may be used for driving and positioning the aerial platform while on the job.

Before operating the upper controls, properly set up the aerial platform as described under Preparing for Operation.

### **⚠ Warning**

The potential for an accident increases from improperly driving or steering the aerial platform. Death or serious injury could result from such accidents. Make sure the upper control panel is at the front of the platform, hooked on the guardrail, and hanging inside the platform.

Avoid driving the platform with the upper controls facing the rear or side of the machine. In this position the machine is difficult to control because the drive and steer control movements and their resulting machine movements will not correspond.

Only operate the upper controls when the panel is at the front of the platform, hooked on the guardrail inside the platform, and facing the front of the machine (refer to Figure 9.2).

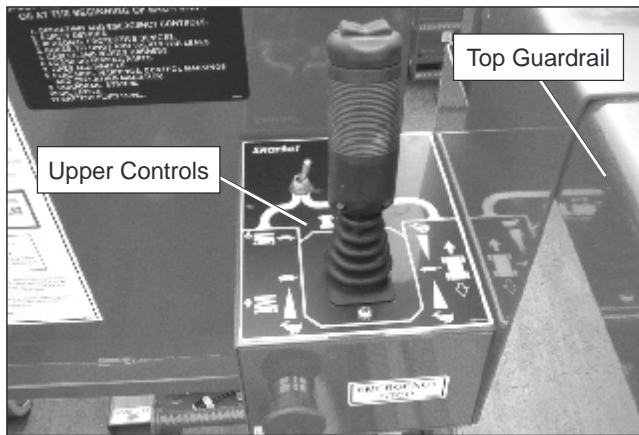

Figure 9.2 – Upper Control Operating Position

Use the following procedure to operate the aerial platform from the upper controls:

1. From the lower controls, pull the emergency stop button outward (refer to Figure 9.1).
2. Place the controls selector upward in the upper controls position.

**Note**

The upper controls will not operate while the control selector is in the lower position.

3. Enter the platform and secure the gate.
4. From the upper controls, pull the emergency stop button outward (refer to Figure 9.3).

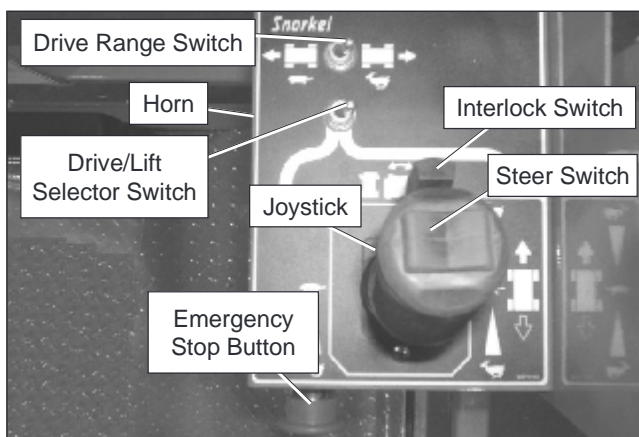

Figure 9.3 – Upper Controls

5. The aerial platform may be driven and the platform may be raised and lowered from the upper controls.

**Platform**

Use care when entering and exiting the platform to avoid slipping and/or falling. Securely close the safety gate when the platform is occupied.

**⚠ Danger**

The potential for an accident increases when the fold down rails are lowered. Death or serious injury can result in such accidents. Do not elevate the platform with the fold down rails lowered. Use extreme care when moving the aerial platform while the fold down rails are lowered.

Be sure the fold down guardrails are up and the hardware is securely tightened, anytime the machine is not being transported.

**Raising and Lowering**

The raise speed is proportional to the joystick position. The farther the joystick is moved, the faster the platform raises. There is only one lowering speed.

1. Place the drive/lift selector switch (refer to Figure 9.3) in the lift position.
2. Squeeze and hold the interlock switch against the joystick.

To raise the platform, slowly push the joystick forward until the desired height is reached.

To lower the platform, pull the joystick backward.

**Extending**

The platform can be extended and securely locked into position.

Use the following procedure to extend the platform:

1. Enter the platform and close the gate.

**⚠ Caution**

The extension deck is free to move when the foot lever is depressed. Personal injury may result from accidentally extending or retracting the deck. Make certain the pin is engaged when the deck is extended in the working position and when it is stowed. Do not attempt to extend or retract the platform unless the aerial platform is on a level surface.

2. While facing the front of the platform, step down on the foot lever and push the top rail of the extension deck forward to extend the deck until the pin engages the mid or front stop (refer to Figure 9.4).

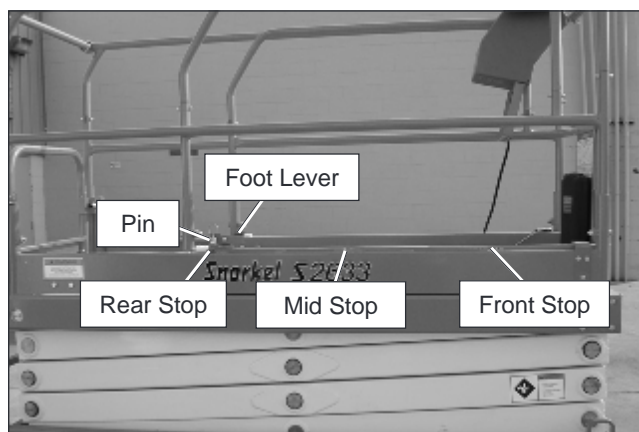

Figure 9.4 – Platform Extension

3. Try to move the rails back and forth to make sure the platform extension deck is locked in position.

Use the following procedure to retract the platform:

1. Enter the platform and close the gate.

### ⚠Caution

The extension deck is free to move when the foot lever is depressed. Personal injury may result from accidentally extending or retracting the deck. Make certain the pin is engaged when the deck is extended in the working position and when it is stowed. Do not attempt to extend or retract the platform unless the aerial platform is on a level surface.

2. While facing the front of the platform, step down on the foot lever and pull the top rail of the extension deck backward until the pin engages the mid or rear stop (refer to Figure 9.4).
3. Try to move the rails back and forth to make sure the platform extension deck is locked in position.

#### Wallboard Loading Gate

The wallboard loading gate is located at the rear of the platform and can be used for loading work materials in the platform.

The gate must be securely fastened closed except when personnel are loading or unloading work materials in the platform.

Use the following procedure to load work materials in the platform using the wallboard loading gate:

1. Remove the retaining pin (refer to Figure 9.5) from the wallboard loading gate.

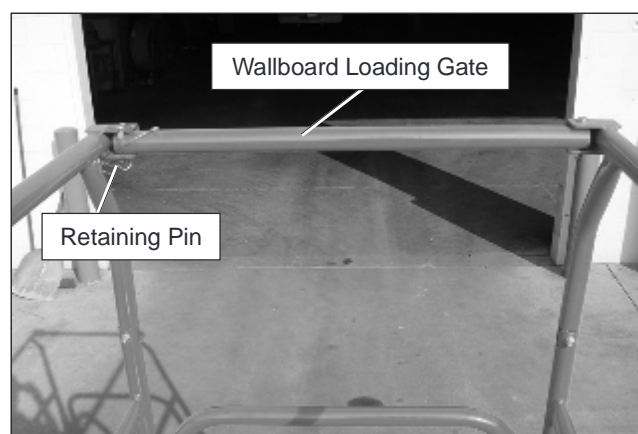

Figure 9.5 – Rear of Platform

2. Swing the gate open.
3. After loading the platform, swing the gate closed and replace the pin.

### Driving and Steering

#### ⚠Danger

The aerial platform can tip over if it becomes unstable. Death or serious injury will result from a tip-over accident. Do not drive an elevated aerial platform on soft, uneven, or sloping surfaces. Do not drive on grades that exceed 25 percent.

A fully stowed machine may be operated on grades up to 25 percent. A grade of 25 percent is a 30" (0.76 m) vertical rise in 10' (3.05 m) horizontal length.

#### ⚠Warning

Death or serious injury could result from improperly driving or steering the aerial platform. Read and understand the information in this manual and on the placards and decals on the machine before operating the aerial platform on the job.

Use the following procedure to operate the drive and steer functions.

1. Place the drive/lift selector switch (refer to Figure 9.3) in the drive position.
2. Push the drive joystick forward to move the chassis forward. Pull the joystick backward to move the chassis backward. The drive speed is proportional to the joystick position.
3. To stop drive motion, return the joystick to neutral.

**Note**

To make an emergency stop push the emergency stop button inward to apply the parking brakes.

4. The steer switch is a momentary contact, rocker switch on top of the drive joystick. This switch controls the two front wheels to steer the aerial platform.

To steer to the right, hold down the right side of the steer switch.

To steer to the left, hold down the left side of the steer switch.

**Note**

Holding the steer switch down too long may result in a sharp turn. This is especially true when driving and steering at the same time. It may be easier to turn the wheels in small increments using a series of quick taps on the steer switch.

5. Set the steer wheels straight ahead after completing a turn. The steering wheels are not self-centering.

**Drive Range Switch – S2632E Only**

The drive range switch has two positions to select drive wheel operation:

High (Rabbit) – for normal driving conditions.

Low (Turtle) – for driving on grades up to 25 percent that require low speed and high torque operation, where high range is not sufficient to climb the grade.

In high the machine will travel up to 2 mph (3.2 km/h) when the platform is raised less than 8' (2.4 m) and up to 0.5 mph (0.8 km/h) when the platform is raised above 8' (2.4 m). Place the drive range switch in high for normal machine operation.

**⚠Caution**

The extension deck is free to move when the pin is disengaged. Make certain the pin is engaged when the deck is extended in the working position and when it is stowed.

Place the drive range switch in low, with the platform fully lowered and the extension deck securely pinned, before driving up a ramp to load the machine for transport.

**Drive Speeds**

The drive speed is proportional to the joystick position. The farther the joystick is moved, the faster the travel speed.

Always slow down before traveling over rough terrain or any sloped surface.

Drive speed ranges are interlocked through limit switches that sense the platform position.

When the platform is elevated below approximately 6' (1.8 m) the aerial platform may be driven with the full range of drive speeds.

When the platform is elevated above 6' (1.8 m) only the slowest drive speed will work.

**⚠Warning**

The potential for an accident increases when safety devices do not function properly. Death or serious injury could result from such accidents. Do not alter, disable, or override any safety device.

Do not use the aerial platform if it drives faster than 0.4 mph (0.6 km/h), which is 7' 7" (5.3 m) in 30 seconds, when elevated above 6' (1.8 m).

**Drive/Lift Level Sensor Interlock**

When the platform is elevated above 6' (1.8 m), lift and drive functions are interlocked through a level sensor system. If the chassis is tilted more than two degrees side-to-side or front-to-rear, platform raise and drive functions are disabled and an alarm sounds when those controls are activated.

If the drive/lift level sensor interlock shuts off the platform raise and drive functions, lower the platform and drive to a level surface.

**Fold Down Guardrails**

The platform guardrails may be folded down to pass the machine under low height obstructions, if the machine is so equipped.

**⚠Danger**

The potential for an accident increases when the fold down rails are lowered. Death or serious injury can result in such accidents. Do not elevate the platform with the fold down rails lowered. Use extreme care when moving the aerial platform while the fold down rails are lowered.

Use the following procedure to lower the platform guardrails.

1. Remove all materials from the platform floor and retract the extension deck.
2. Remove the upper control panel from the side guardrail and place it on the floor of the platform.
3. Remove the pins (refer to Figure 9.6) that connect the front panel to the guardrails on the right side of the platform extension. Fasten the front panel to the mid rail on the left side of the platform.

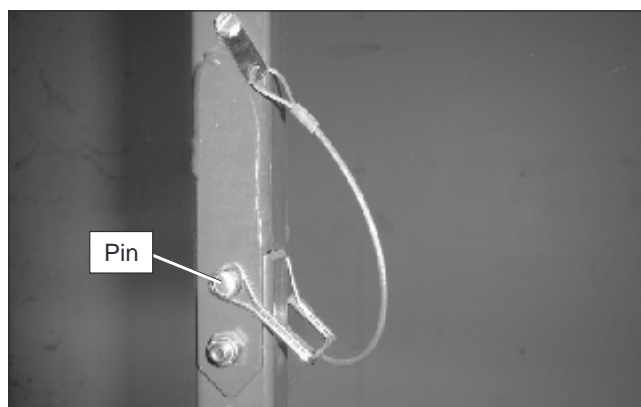

Figure 9.6 – Platform Pin

- Remove the pins from the platform extension deck vertical rails and fold the guardrails down to rest on the floor of the platform.

#### Note

It may be necessary to extend the platform approximately 6" (15 cm) to remove the pins at the front of the platform. If so, make certain to relock the extension deck in the stowed position.

- Remove the pins (refer to Figure 9.6) that connect the rear panel to the guardrails on the right side of the platform. Fasten the rear panel to the mid rail on the left side of the platform.
- Remove the pins from the platform deck vertical rails and fold the guardrails down to rest on the floor of the platform.
- Reverse this procedure to reposition the rails.

### Swing-Out Trays

Batteries and hydraulic components are enclosed in swing-out trays (refer to Figure 9.7) on each side of the chassis.

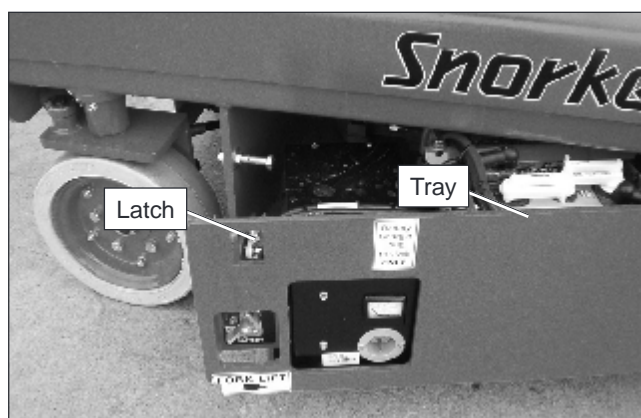

Figure 9.7 – Swing-Out Tray

The battery tray on the left side of the chassis contains the battery disconnect, batteries and the battery charger.

The hydraulic tray on the right side of the chassis contains the lower controls, the hydraulic reservoir, and the hydraulic fluid filter.

### **⚠ Danger**

The aerial platform can tip over if it becomes unstable. Death or serious injury can result from a tip-over accident. Do not open the trays when the platform is raised more than eight feet.

To open the swing-out tray, push down on the latch and swing the tray open.

### Electrical Power Outlet

The electrical power outlet has two, 3-prong, 125 volt AC electrical connectors (refer to Figure 9.8). Their combined output is limited by a 15 amp circuit breaker.



Figure 9.8 – Electrical Power Outlet

Power is supplied to the outlet by connecting an external power source to the power-input connector at the rear of the chassis (refer to Figure 9.9).

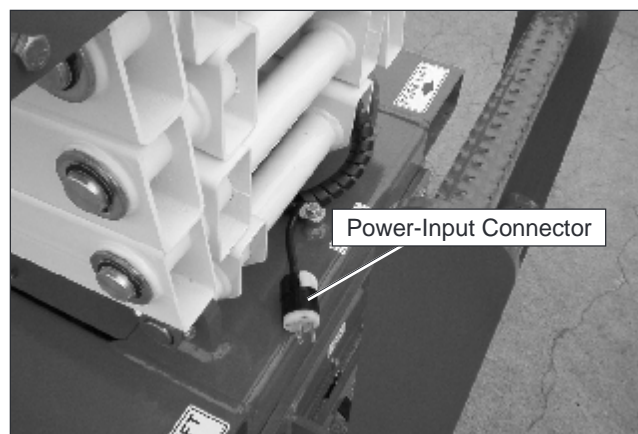

Figure 9.9 – Rear of Chassis

To use the outlet, plug a source of power into the power-input connector. Unplug the source of power before moving the aerial platform.



## Chapter 10 – Stowing and Transporting

To prevent unauthorized use and damage, properly stow the aerial platform at the end of each work day. It must also be properly stowed while transporting.

### Stowing

Use the following procedure to properly stow the aerial platform.

1. Fully retract the platform extension deck and ensure the pin is engaged in the back stop.

#### **⚠Caution**

The extension deck is free to move when the pin is removed. Make certain the pin is in place when the deck is extended in the working position and when it is stowed.

2. Fully lower the platform.
3. Push the emergency stop button in on the lower control panel.
4. Turn the battery disconnect switch off and lock it.
5. Securely close the swing-out trays.

### Transporting

The aerial platform may be moved on a transport vehicle. Depending on the particular situation, the aerial platform may be lifted with a forklift, driven, winched, or hoisted onto a vehicle such as a truck or trailer. Lifting with a forklift is the preferred method.

The equipment used to load, unload, and transport the aerial platform must have adequate capacity. The empty vehicle weight is listed in Chapter 2 and is stamped on the serial number placard.

The user assumes all responsibility for:

Choosing the proper method of transportation.

Choosing the proper selection and use of transportation and tie-down devices.

Making sure the equipment used is capable of supporting the weight of the aerial platform.

Making sure all manufacturer's instructions and warnings, regulations and safety rules of their employer, the DOT, and/or any other state or federal law are followed.

#### Lifting With a Forklift

Use the following procedure to lift the aerial platform with a forklift.

1. Properly stow the aerial platform.

2. Remove all personnel, tools, materials, or other loose objects from the platform.
3. If lifting from the rear of the machine, insert the forklift forks into the pockets (refer to Figure 10.1).

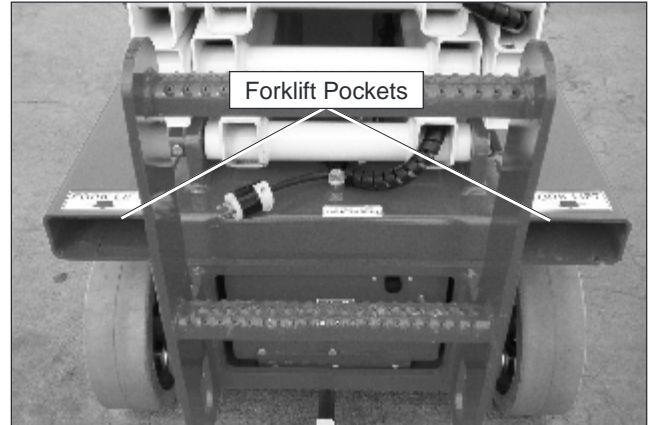

Figure 10.1 – Rear of Chassis

#### **⚠Caution**

Lifting the aerial platform with the forklift forks positioned improperly can produce enough force to damage machine components. When lifting the machine from the side, place the forklift forks directly under the designated lift points.

4. If lifting from either side of the machine, place the forklift forks directly under the designated points under the pothole protector skid (refer to Figure 10.2).

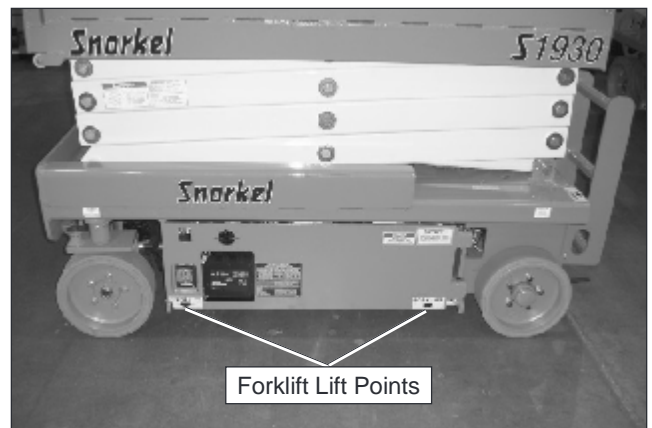

Figure 10.2 – Side of Chassis

5. Do not raise the aerial platform higher than necessary to transport it. Drive the forklift slowly and carefully when transporting the aerial platform.

### Winching

Use a winch to load and unload the aerial platform on ramps that exceed the machine gradeability specification. A winch may also be used when poor traction, uneven surfaces, or stepped ramp transition make driving hazardous.

Use the following procedure to winch the aerial platform onto the transport vehicle.

1. Position the transport vehicle so the aerial platform will not roll forward after it is loaded.
2. Remove any unnecessary tools, materials, or other loose objects from the platform.
3. Drive the machine to the foot of the loading ramp with the front wheels nearest the ramp. Make sure the machine is centered with the ramps and that the steering wheels are straight.
4. Properly stow the aerial platform.

### Warning

The aerial platform is free to move when the brakes are released. Death or serious injury can result. Re-enable the brakes before operating the aerial platform.

5. Chock the wheels to prevent uncontrolled motion of the aerial platform.
6. Unlatch and swing out the hydraulic tray on the right side of the chassis. The brake release valve, pump, and free-wheeling valves are located on the hydraulic manifold on the S1930E and S1932E machines (refer to Figure 10.3).

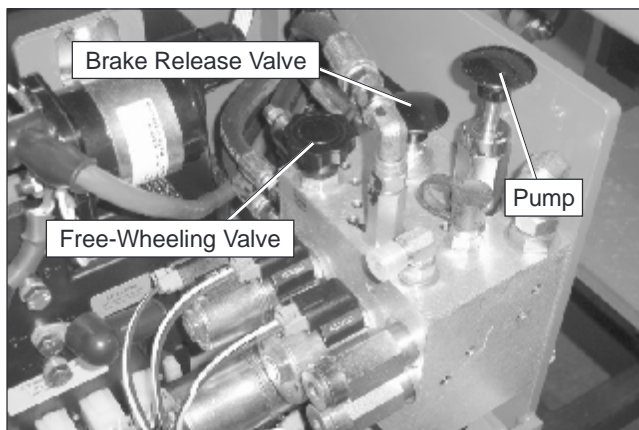

Figure 10.3 – S1930E/S1932E Hydraulic Tray

On S2632E machines the brake release pump and a manual brake reset valve is located on the hydraulic manifold (refer to Figure 10.4).

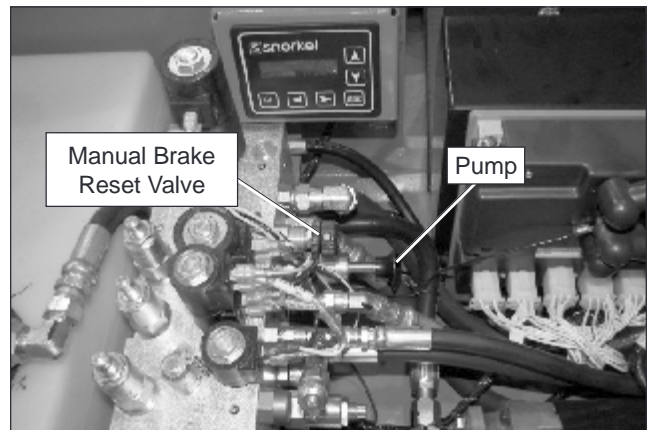

Figure 10.4 – S2632E Hydraulic Tray

On S2632E machines the free-wheeling valve is at the rear of the chassis, inside the step as shown in Figure 10.5.



Figure 10.5 – S2632E Rear of Chassis

7. On S1930E and S1932E machines, press downward on the brake release valve to the fully open position. This step is not required on the S2632E machines.
8. Turn the free-wheeling valve counterclockwise to the fully open position.
9. Push and release the brake release pump knob until it can no longer be pumped.
10. Attach the winch line to the tie-down lugs (refer to Figure 10.6) on the front of the chassis.



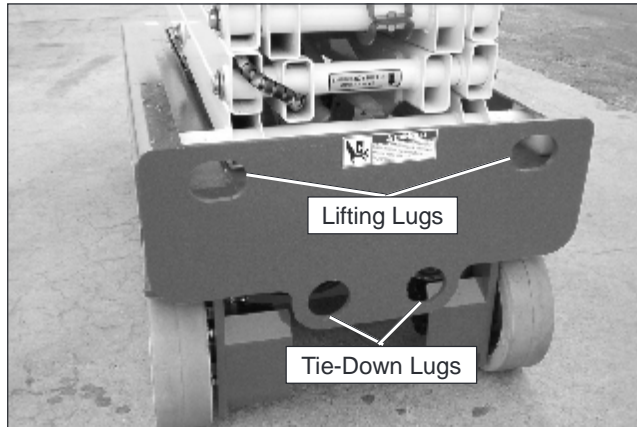

Figure 10.6 – Front of Chassis

11. Remove the wheel chocks and use the winch to position the aerial platform on the transport vehicle.

### ⚠ Warning

The aerial platform is free to move when the brakes and free-wheeling valve are disabled. Death or serious injury could result. Close the free-wheeling valve and reset the brakes before operating the aerial platform.

12. Close the free-wheeling valve.
13. Drive the aerial platform forward or reverse and then stop to reset the parking brakes.

On S1930E and S9132E machines the brake release valve can be heard when it resets, as the machine is driven.

On S2632E machines, if the brakes do not reset, turn the manual brake reset valve fully open (counterclockwise) and then back to the fully closed (clockwise) position to reset the brake valve.

14. Verify that the drive system and brakes operate properly before operating the aerial platform.

### Driving

### ⚠ Danger

The aerial platform can tip over if it becomes unstable. Death or serious injury will result from a tip-over accident. Do not drive on ramps that exceed the machine gradeability specification, or where conditions of the ramp could cause driving to be hazardous.

Use a winch to load and unload the aerial platform on ramps that exceed the machine gradeability specification. A winch may also be used when poor traction, uneven surfaces, or stepped ramp transitions make driving hazardous.

Drive the aerial platform onto the transport vehicle if a winch is not available and the ramp incline is within the 25 percent grade capability of the aerial platform.

Use the following procedure to drive the aerial platform onto the transport vehicle.

1. Position the transport vehicle so the aerial platform will not roll forward after it is loaded.
2. Chock the vehicle wheels so it cannot roll away from the ramp while the aerial platform is loaded.
3. Remove any unnecessary tools, materials, or other loose objects from the platform.

### ⚠ Caution

The extension deck is free to move when the pin is removed. Make certain the pin is in place when the deck is extended in the working position and when it is stowed.

4. Retract the platform extension deck and ensure the pin is in place. Fully lower the platform.
5. Drive the aerial platform to the foot of the loading ramp with the front wheels nearest the ramp. Make sure the aerial platform is centered with the ramps and that the steering wheels are straight.
6. On S2632E machines, place the drive range switch in low (turtle) for climbing or descending a ramp.
7. Drive the aerial platform on or off the transport vehicle in a straight line through the grade transitions with minimal turning.

### Hoisting

Use a four point sling arrangement attached to the lifting lugs when hoisting the aerial platform. Machine damage can occur if the sling is attached anywhere else.

### ⚠ Warning

The potential for an accident increases when the aerial platform is lifted using improper equipment and/or lifting techniques. Death or serious injury could result from such accidents. Use proper equipment and lifting techniques when lifting the aerial platform.

Know the weight of the aerial platform and the capacity of the lifting devices before hoisting.

Lifting devices include the hoist or crane, chains, straps, cables, hooks, sheaves, shackles, slings, and other hardware used to support the machine.

The empty vehicle weight is stamped on the serial number placard and is listed in Chapter 2.

The user assumes all responsibility for:

Making sure the equipment used is capable of supporting the weight of the aerial platform.

Making sure all manufacturer's instructions and warnings, regulations and safety rules of their employer and/or any state or federal law are followed.

Use the following procedure to hoist the aerial platform onto the transport vehicle:

1. Properly stow the aerial platform.
2. Inspect the front lifting lugs and the rear lifting lugs (refer to Figures 10.6 and 10.7) to make sure they are free of cracks and are in good condition. There are two lugs on the rear of the chassis and two on the front. Have any damage repaired by a qualified service technician before attempting to hoist the machine.



Figure 10.7 – Rear of Chassis

3. Remove all personnel, tools, materials, or other loose objects from the platform.
4. Connect the chains or straps to the lifting lugs using bolted shackles. Hooks that fit properly in the lugs and that have latching mechanisms to prevent them from falling out under a slack line condition may also be used.

Do not run the sling cable through the lifting lugs.

Cable damage and/or failure can result from the cable contacting the sharp corners of the lug.

There is no effective way of putting a corner protector in the hole of the lug.

5. Use spreader bars of sufficient length to keep the chains, straps, or cables from contacting the scissors structure or platform.

When using cables, use rigid corner protectors at any point where the cable contacts on sharp corners to prevent damaging the cable.

Careful rigging of the spreaders is required to prevent machine damage.

6. Adjust the length of each chain or strap so the aerial platform remains level when raised off the ground.
7. Use the hoist or crane to carefully raise and position the aerial platform onto the transport vehicle.

#### Securing for Transport

Use the following procedure to secure the aerial platform on the transport vehicle.

1. Chock the wheels.
2. Remove all personnel, tools, materials, or other loose objects from the platform.
3. Properly stow the aerial platform.
4. Place wood blocks under the front ends of the pothole protection skids to limit excessive loading on the front drive wheel bearings.
5. Place the lower controls emergency stop switch in the off position.
6. Turn the battery disconnect switch off.

#### **⚠Caution**

Ratchets, winches, and come-alongs can produce enough force to damage machine components. Do not over tighten the straps or chains when securing the aerial platform to the transport vehicle.

7. Use chains or straps to securely fasten the aerial platform to the transport vehicle using the front and rear tie-down lugs as attachment points. Proper tie-down and hauling is the responsibility of the carrier.

## Chapter 11 – Emergency Operation

If the main hydraulic system fails:

The aerial platform may be lowered using the emergency lowering lever.

The machine may be towed if the drive system fails.

Refer to Emergency Lowering, or Towing for the appropriate procedure.

### Emergency Lowering

Use the following procedure to operate the emergency lowering system.

#### ⚠Warning

The potential for an accident increases when safety devices do not function properly. Death or serious injury can result from such accidents. Immediately push the emergency stop button inward to disable the control system before using the emergency lowering system in the event of an emergency.

1. Immediately push the emergency stop button inward to disable the control system in the event of an emergency.
2. Retract the platform extension, if possible.
3. Locate the emergency lowering control. On S1930E and S1932E machines the lowering lever is at the front of the aerial platform. On S2632E machines a handle at the rear of the chassis is used for emergency lowering (refer to Figure 11.1).

#### ⚠Danger

Pinch points may exist between moving components. Death or serious injury will result from becoming trapped between components. Make sure all personnel stand clear while lowering the platform with the emergency lowering system.

4. Make sure there is nothing in the way to obstruct the platform when it lowers.
5. While standing clear of the scissors structure, engage the control. The platform will begin to lower as the lever is pushed down.

S1930E and S1932E machines – push downward on the lever to lower the platform.

S2632E machines – pull outward on the handle to lower the platform.

6. Release the lever/handle to stop the platform from lowering.

#### ⚠Warning

The potential for an accident increases when safety devices do not function properly. Death or serious injury could result from such accidents. Fully close the emergency lowering valve before operating the aerial platform.

7. Make certain the lever/handle is fully released and the emergency lowering valve is fully closed before operating the aerial platform.

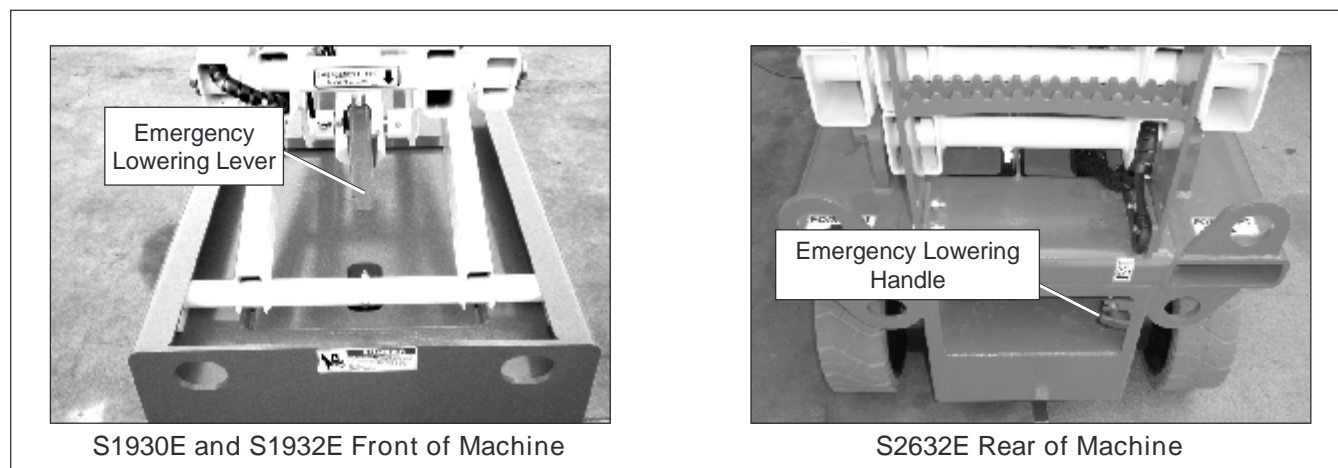

Figure 11.1 – Emergency Lowering Control

### Towing – S1930 and S1932E

The aerial platform may be pushed or pulled after properly stow the aerial platform and disengaging the brakes. Use the following procedure to manually disengage the brakes.

#### **⚠Warning**

The aerial platform is free to move when the brakes are released. Death or serious injury could result. Re-enable the brakes before operating the aerial platform.

1. Chock the wheels to prevent uncontrolled motion of the aerial platform and turn the battery disconnect switch off.
2. Unlatch and swing out the hydraulic tray on the right side of the chassis. The brake release valve, pump, and free-wheeling valves are located on the hydraulic manifold on the S1930E and S1932E machines (refer to Figure 11.2).

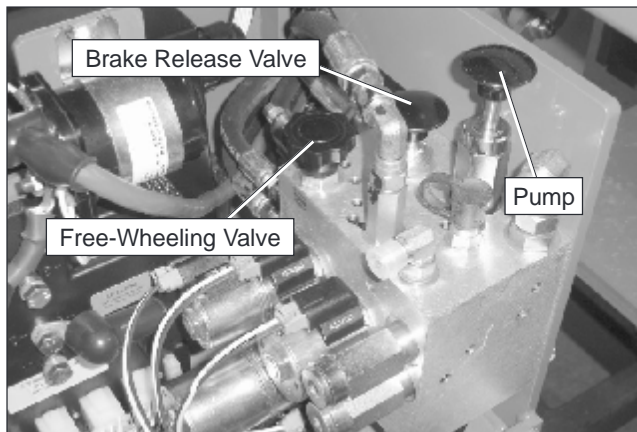

Figure 11.2 – S1930E/S1932E Hydraulic Tray

On S2632E machines the brake release pump and a manual brake reset valve is located on the hydraulic manifold (refer to Figure 11.3).

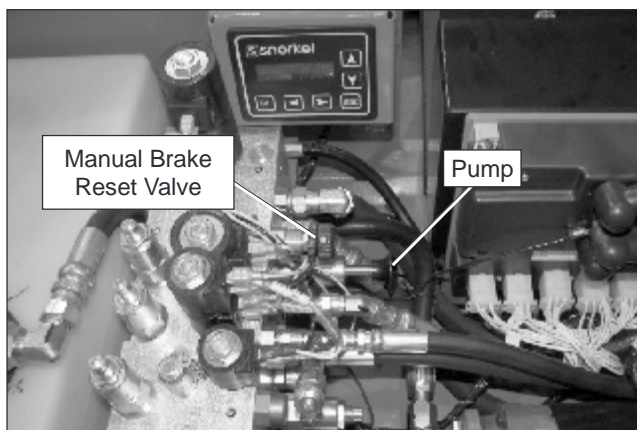

Figure 11.3 – S2632E Hydraulic Tray

On S2632E machines the free-wheeling valve is at

the rear of the chassis, inside the step as shown in Figure 11.4.



Figure 11.4 – S2632E Rear of Chassis

3. On S1930E and S1932E machines, press downward on the brake release valve to the fully open position. This step is not required on the S2632E machines.
4. Turn the free-wheeling valve counterclockwise to the fully open position.
5. Push and release the brake release pump knob until it can no longer be pumped.
6. Do not exceed 2 mph (3.2 km/h) when towing.

#### **⚠Warning**

The aerial platform is free to move when the brakes and free-wheeling valve are disabled. Death or serious injury could result. Close the free-wheeling valve and reset the brakes before operating the aerial platform.

7. Close the free-wheeling valve after towing.
8. Drive the aerial platform forward or reverse and then stop to reset the parking brakes.

On S1930E and S9132E machines the brake release valve can be heard when it resets, as the machine is driven.

On S2632E machines, if the brakes do not reset, turn the manual brake reset valve fully open (counterclockwise) and then back to the fully closed (clockwise) position to reset the brake valve.

9. Verify that the drive system and brakes operate properly before operating the aerial platform.

## Chapter 12 – Troubleshooting

The troubleshooting chart may be used to locate and eliminate situations where machine operation may be interrupted. If the problem cannot be corrected with the

action listed, stow the machine and remove it from service. Repairs must be made by qualified maintenance personnel.

### Troubleshooting Chart

Symptom	Possible Cause	Corrective Action
All functions stop working.	Motor or pump failure.	Manually stow the machine using the emergency lowering lever/handle.
	Low Fluid level in reservoir.	Check hydraulic Fluid level. Add correct type of Fluid if necessary.
	Batteries discharged.	Recharge batteries.
	Electrical system malfunction.	Stow the machine and do not operate until repairs are made.
Platform will not raise or lower from lower controls.	Control selector switch is in the upper control position.	Place the switch in the lower control position.
	Battery disconnect is turned off.	Place the switch in the on position.
	Emergency stop button is pushed inward to the off position.	Pull the emergency stop button outward to the on position.
	Emergency lowering lever is not properly disengaged.	Make sure the lever returns to the normal operating position.
Platform will not raise or lower from upper controls.	Drive/lift selector is in the drive position.	Place switch in the lift position.
	Emergency lowering lever not properly disengaged.	Make sure the lever returns to the normal operating position.
Platform will not raise and alarm is sounding.	Machine is not on a level surface.	Lower the platform and drive to a level surface.
Platform will not raise, or raises slower than normal.	Emergency lowering lever/handle not properly disengaged.	Make sure the lever/handle returns to the normal operating position.
	Platform capacity has been exceeded.	Remove load from platform. Refer to platform capacity placard for maximum capacity.
	Low battery charge.	Check the battery charge indicator and recharge the batteries if necessary.
Platform drifts down.	Emergency lowering lever not properly disengaged.	Make sure the lever returns to the normal operating position.
	Hydraulic system malfunction.	Stow the machine and do not operate until repairs are made.
Platform will not lower.	Safety prop in place.	Stow the safety prop.
Platform will not extend.	Latch pin still in place.	Remove the latch pin before extending the platform.
Drive functions don't work.	Drive/lift selector is in the lift position.	Place the switch in the drive position.
	Machine is not on a level surface or too steep a grade.	Lower the platform and drive to a level surface.
	Free-wheeling valve is open.	Fully close the free-wheeling valve.
	Load capacity exceeded.	Remove load from platform. Refer to platform capacity placard for maximum capacity.
	Low hydraulic system pressure.	Stow the machine and do not operate until repairs are made.
Machine will not climb a 25 percent grade – S2632E only.	Drive range selector is not in the low (turtle) position.	Place the switch in the low (turtle) position.

Symptom	Possible Cause	Corrective Action
Only slow drive speed works.	Platform elevated above 7 to 8 feet (2.1 to 2.4 m).	Normal operation, lower platform to drive machine at faster speed.
	Drive range selector is in the low (turtle) position – S2632E only.	Place the switch in the high (rabbit) position.
Machine will not steer.	Joystick interlock switch not engaged.	Engage the interlock switch before operating the steer switch.
Wheels won't turn when winching or pushing.	Brakes are engaged.	Manually release the brakes using the hand pump. Refer to Towing, Chapter 11.
	Free-wheeling valve closed.	Fully open free-wheeling valve.
Tilt alarm does not work.	Platform is not raised more than 6' (1.8 m).	Normal operation. The tilt alarm is not active until the platform is raised more than 6' (1.8 m).
Battery charger does not indicate a reading when charging batteries.	No source of power.	Make sure power source is plugged in and turned on.
	Faulty batteries or charger.	Stow the machine and do not operate until repairs are made.
Hydraulic fluid temperature of 160°F (71°C) or more.	Prolonged driving or platform operation.	Stop operation until fluid cools.
	High pressure fluid return to reservoir caused by kinked or twisted hose.	Remove the kink or twist from the hose. Let fluid cool before resuming operation.
	Hydraulic system component failure.	Stow the machine and do not operate until repairs are made.
Severe hydraulic leak.	Failure of hose, tube, fitting, seal, etc.	Stow the machine and do not operate until repairs are made.

# Appendix A – Glossary

aerial platform – a mobile device that has an adjustable position platform, supported from ground level by a structure.

ambient temperature – the air temperature of the immediate environment.

authorized personnel – personnel approved as assigned to perform specific duties at a specific location.

base – the relevant contact points of the aerial platform that form the stability support (e.g. wheels, casters, stabilizers).

battery tray – a swing-out compartment that holds the batteries, battery charger, and the battery disconnect plug.

center of gravity – the point in the aerial platform around which its weight is evenly balanced.

chassis – the integral part of the aerial platform that provides mobility and support for the scissors structure.

fall restraint – a system that is used while working on a boom lift within the boundaries of platform guardrails to provide restraint from being projected upward from the platform. This system includes a harness or belt, lanyard, and a lanyard anchor. Although federal regulations, OSHA, ANSI, and Snorkel do not require the use of additional fall protection beyond the platform guardrails on scissor lift aerial platforms, local, state, or employer rules may require their use.

Åoor or ground pressure – the maximum pressure, expressed in pounds per square inch, a single wheel concentrates on the Åoor or ground.

free-wheeling valve – a needle valve that, when adjusted open, allows hydraulic Åuid to Åow through the wheel drive motors. This allows the aerial platform to be pushed or towed without damaged to the drive motors.

gradeability – the maximum slope that the aerial platform is capable of travel.

ground fault circuit interrupter (GFCI) – a fast-acting circuit breaker that opens to stop electrical circuit Åow if it senses a very small current leakage to ground. The GFCI is used to protect personnel against a potential shock hazard from defective electrical tools or wiring.

guardrail system – a vertical barrier around the platform to prevent personnel from falling.

hazardous location – any location that contains, or has the potential to contain, an explosive or Åammable atmosphere as defined by ANSI/NFPA 505.

hydraulic tray – a swing-out compartment that holds the electrical panel for the lower controls, the hydraulic Åuid reservoir, and the hydraulic Åuid Ålter.

level sensor – a device that detects a preset degree of variation from perfect level. The level sensor is used to sound an alarm if operating on a slope greater than the preset value.

lower controls – the controls located at ground level for operating some or all of the functions of the aerial platform.

manufacturer – a person or entity who makes, builds or produces an aerial platform.

maximum travel height – the maximum platform height or the most adverse configuration(s) with respect to stability in which travel is permitted by the manufacturer.

maximum wheel load – the load or weight that can be transmitted through a single wheel to the Åoor or ground.

Minimum Safe Approach Distance (M.S.A.D.) – the minimum safe distance that electrical conductors may be approached when using the aerial platform.

operation – the performance of any aerial platform functions within the scope of its specifications and in accordance with the manufacturer's instructions, the users work rules, and all applicable governmental regulations.

operator – a qualified person who controls the movement of an aerial platform.

personal fall arrest system – a fall protection system that is used while working on an unprotected edge (such as a roof top with no guardrail). This system includes a harness, lanyard or other connecting device, a fall arrestor, an energy absorber or decelerator, an anchorage connector, and a secure anchorage such as a building beam, girders or columns. An aerial platform is not a fall arrest anchorage.

platform – the portion of an aerial platform intended to be occupied by personnel with their tools and materials.

platform height – the vertical distance measured from the Åoor of the platform to the surface upon which the chassis is being supported.

pothole protection interlock – a safety feature that sounds an alarm and automatically stops the platform raise function if the pothole protection skids are prevented from lowering properly.

pothole protection system – a mechanical tip-over prevention system consisting of skids along the bottom of both sides of the chassis which lower as the platform is raised.

prestart inspection – a required safety inspection routine that is performed daily before operating the aerial platform.

qualified person – a person, who by reason of knowledge, experience, or training is familiar with the operation to be performed and the hazards involved.

rated work load – the designed carrying capacity of the aerial platform as specified by the manufacturer.

safety prop – a bar that when properly positioned mechanically prevents the platform from lowering.

stow – to place a component, such as the platform, in its rest position.

turning radius – the radius of the circle created by the wheel during a 360° turn with the steering wheels turned to maximum. Inside turning radius is the wheel closest to the center and outside turning radius is the wheel farthest from the center.

unrestricted rated work load – the maximum designed carrying capacity of the aerial platform allowed by the manufacturer in all operating configurations.

upper controls – the controls located on or beside the platform used for operating some or all of the functions of the aerial platform.

wheelbase – the distance from the center of the rear wheel to the center of the front wheel.

working envelope – the area defined by the horizontal and vertical limits of travel that the platform may be positioned in.

working height – platform height plus six feet (1.8 meters).







## Product Warranty

1. Snorkel warrants each new machine manufactured and sold by it to be free from defects in material and workmanship for a period of one (1) year from date of delivery to a Customer. The warranty will apply subject to the machine being operated in accordance with the rules, precautions, instructions and maintenance requirements outlined in the Snorkel Operator's and Repair Parts Manuals.
2. Snorkel further warrants the structural components, specifically the mainframe chassis, turntable, booms and/or scissor arms of each new machine manufactured by it to be free from defects in material and workmanship for an additional period of four (4) years. Any such part or parts which, upon examination by the Snorkel Warranty Department, are found to be defective will be replaced or repaired by Snorkel through its local Authorised Dealer. The structural warranty specifically excludes adverse effects on the machine structure arising from damage, abuse or misuse of the equipment.
3. Machines may be held in an authorised Distributor stock for a maximum of six (6) months from the date of shipment from Snorkel, before the warranty period is automatically initiated.
4. It is the responsibility of the Distributor to complete and return a Predelivery/Warranty registration, before the act of rental/loan/demonstration of the machine or delivery to an end user.
5. The Customer and Dealer shall not be entitled to the benefits of this warranty and Snorkel shall have no obligations here under unless the "Predelivery and Inspection Record" has been properly completed and returned to the Snorkel Warranty department within fifteen (15) days after delivery of the Snorkel product to the Customer or Dealer's demonstration/rental fleet. Snorkel must be notified, in writing, within ten (10) days, of any machine sold to a Customer from a Dealer's rental fleet during the warranty period.
6. Any part or parts which upon examination by the Snorkel Product Support Department are found to be defective within the specified warranty period, will be replaced or repaired at the sole discretion of Snorkel, through Snorkel directly or an authorised Distributor, at no charge. Any parts replaced under warranty must be original Snorkel parts obtained through Snorkel directly or an authorised Distributor, unless expressly agreed otherwise in writing and in advance by Snorkel's Warranty Department.
7. All parts being claimed under warranty must be held available for return and inspection upon request for a period of 90 days from date of claim submission, it is necessary that all parts are individually tagged or marked with their part number and the warranty claim number. After 90 days all parts replaced under warranty which have not been returned to Snorkel should be destroyed. Failure to produce parts requested by the Warranty Administrator for inspection within a period of 14 days will result in the claim being automatically rejected in full. Materials returned for warranty inspection must have the following procedure:

Carefully packaged to prevent additional damage during shipping  
Drained of all contents and all open ports capped or plugged  
Shipped in a container tagged or marked with the RMA number  
Shipped PREPAID. Any item(s) returned for warranty by any other means maybe refused and returned, unless prior approval is agreed with Snorkel.



## Product Warranty

- At the direction of the Snorkel Warranty Department, any component part(s) of Snorkel products to be replaced or repaired under this warranty program must be returned freight prepaid for inspection. An RMA (Returns Material Authorisation) must be requested from Snorkel Warranty Department, a copy to be placed with the returning component part(s).
- All warranty replacement parts will be shipped freight prepaid (standard charge) from the Snorkel Parts/Service Department or from the Vendor to Dealer or Customer.
- All warranty claims are subject to approval by Snorkel Service Department. Snorkel reserves the right to limit or adjust claims with regard to defective parts, labor or travel time based on usual and customary guidelines.

### REPLACEMENT PARTS WARRANTY

Any part replaced under this limited warranty is not subject to further warranty cover beyond the normal warranty period of the machine upon which the part was installed.

Any replacement parts sold (not delivered under a warranty claim) will be subject to a warranty period of (6) six months from the date of invoice.

Parts held by a Distributor are covered under warranty for a period of (12) twelve months from the date of invoice, provided that those parts have been subject to appropriate storage to prevent damage and deterioration.

### CLAIM PROCEDURE

The Snorkel Warranty Department must be notified within (48) forty-eight hours of any possible warranty situation during the applicable warranty period. Personnel performing major warranty repair or parts replacement must obtain specific approval by the Snorkel Warranty Department prior to performing the warranty repair or replacement.

When a Distributor/Customer perceive a warranty issue to exist the following steps must be adhered to:

All warranty claims must be submitted within 30 days of the date of the machine repair

All correspondence in respect of the claim to be on an official Snorkel warranty claim form as supplied by Snorkel's Warranty Department

Allocate a warranty claim number to the repair

Place a purchase order for genuine Snorkel replacement parts

Snorkel to dispatch parts via the requested method (in line with the required response time)

Confirmation that a qualified technician is available to replace the part and that this person has been accepted by Snorkel to carry out such work under the warranty of the machine. Failure to do this may nullify the warranty.

### FREIGHT DAMAGE

If a machine is received in a damaged condition, then the damage must be noted on the bill of lading and/or delivery documents and if possible photographs taken, prior to signing acceptance of the consignment. The freight company must be contacted by the Distributor and a damage claim registered immediately.

### THIS WARRANTY EXCLUDES AND SNORKEL DOES NOT WARRANT:

- Engines, motors, Gases and batteries are manufactured by suppliers to Snorkel, who furnish their own warranty. Snorkel will, however, to the extent permitted; pass through any such warranty protection to the Distributor/Customer.
- Any Snorkel product which has been modified or altered outside Snorkel factory without Snorkel written approval, if such modification or alteration, in the sole judgment of Snorkel Engineering and/or Service Departments, adversely affects the stability, reliability or service life of the Snorkel product or any component thereof.



## Product Warranty

3. Any Snorkel product which has been subject to misuse and abuse, improper maintenance or accident. "Misuse" includes but is not limited to operation beyond the factory-rated load capacity and speeds. "Improper maintenance" includes but is not limited to failure to follow the recommendations contained in the Snorkel Operator's and Repair Parts Manuals.
4. Normal wear of any Snorkel component part(s). Normal wear of component parts may vary with the type, application or type of environment in which the machine may be used; such as, but not limited to sandblasting applications.
5. Routine maintenance, routine maintenance items and minor adjustments are not covered by this warranty, including but not limited to hydraulic fluid, filters and lubrication, paint and decals.
6. Any Snorkel product that has come into direct contact with any chemical or abrasive material.
7. Incidental or consequential expenses, losses, or damages related to any part or equipment failure, including but not limited to freight cost to transport the machine to a repair facility, downtime of the machine, lost time for workers, lost orders, lost rental revenue, lost profits, expenses or increased cost. This warranty is expressly in lieu of all other warranties, representations or liabilities of Snorkel, either expressed or implied, unless otherwise amended in writing by Snorkel.
8. Snorkel Warranty policy does not cover any duties, taxes, environmental fees including without limitation, disposal or handling of tires, batteries and petrochemical items.
9. Items specifically excluded are, fuel injectors, motor brushes, glow plugs, contactor tips and springs, oil filters, lamp bulbs, lamp lenses, O-rings, coolants, lubricants and cleaning material.
10. Failure of replacement parts due to fault misdiagnosis or incorrect fitting by the Distributor/Customer.

SNORKEL MAKES NO WARRANTIES WHICH EXTEND BEYOND THE DESCRIPTION OF THIS LIMITED WARRANTY

SNORKEL MAKES NO IMPLIED WARRANTY OF MERCHANTABILITY OR FITNESS FOR A PARTICULAR PURPOSE AND DISCLAIMS ALL LIABILITY FOR INCIDENTAL OR CONSEQUENTIAL DAMAGES, INCLUDING BUT NOT LIMITED TO INJURY TO PERSONS OR PROPERTY.

The Customer shall make all warranty claims through Snorkel directly or an Authorized Distributor. If unable to contact the Distributor, contact the Snorkel Service Department for further assistance.



# Product Warranty

## APPEAL

The buyer may appeal in writing against a rejected or adjusted claim to Snorkel Warranty Department within a period of 21 days of receiving the rejection or adjustment notice. The appeal should be grounded on express reasons and supported by relevant evidence. Appeals received outside of this time limit will not be considered.

## WARRANTY SCHEDULE

### Limited Warranty Periods

Item	Warranty Period
New machine materials and workmanship	1 year parts replacement
Structural components (Chassis, Turntable, Booms, Scissors)	5 years parts replacement or repair
Parts held in a Distributor's stock	12 months from date of invoice
Parts sold (non warranty)	6 months from date of invoice
Batteries	6 months from date of invoice
Other specifically excluded parts: Fuel injectors Motor brushes Glow plugs Contactor tips and springs Oils Filters Lamp bulbs Lamp lenses O-rings Coolants Lubricants Cleaning materials	Not covered by Warranty



Local Distributor / Lokaler Vertiebs Händler / Distributeur local  
El Distribuidor local / Il Distributore locale

EUROPE, MIDDLE EAST  
AFRICA & ASIA  
PHONE: +44 (0) 845 1550 058  
FAX: +44 (0) 845 1557 756

NORTH & SOUTH AMERICA  
PHONE: +1 785 989 3000  
TOLL FREE: +1 800 255 0317  
FAX: +1 785 989 3070

AUSTRALIA  
PHONE: +61 1300 700 450  
FAX: +61 2 9609 3057

NEW ZEALAND  
PHONE: +64 6 3689 168  
FAX: +64 6 3689 164

 **snorkel**

[www.snorkellifts.com](http://www.snorkellifts.com)